

TOSHIBA

fire tv edition 32" 60 Hz LED TV

QUICK SETUP GUIDE

32LF221C21

INCLUDED ACCESSORIES



Voice Remote with Alexa and two AAA batteries



Stands

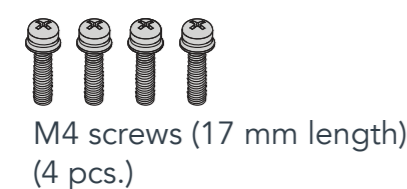

M4 screws (17 mm length) (4 pcs.)



Power cord

FIND YOUR USER GUIDE ONLINE!
Go to www.tv.toshiba.com and search for 32LF221C21.

WHAT YOU NEED (not included)

- Phillips screwdriver
- Internet connection (wired or wireless)*

*Subscription or other payment may be required to access certain content.

1 START HERE

How do I attach the stands to my TV? (not for wall mounting)
 You'll need: Soft surface and a Phillips screwdriver.
 Carefully place your TV face-down on a cushioned, clean surface.
 Secure each TV stand to the bottom of your TV with two of the provided screws.
 The stands are labeled R (right) and L (left).

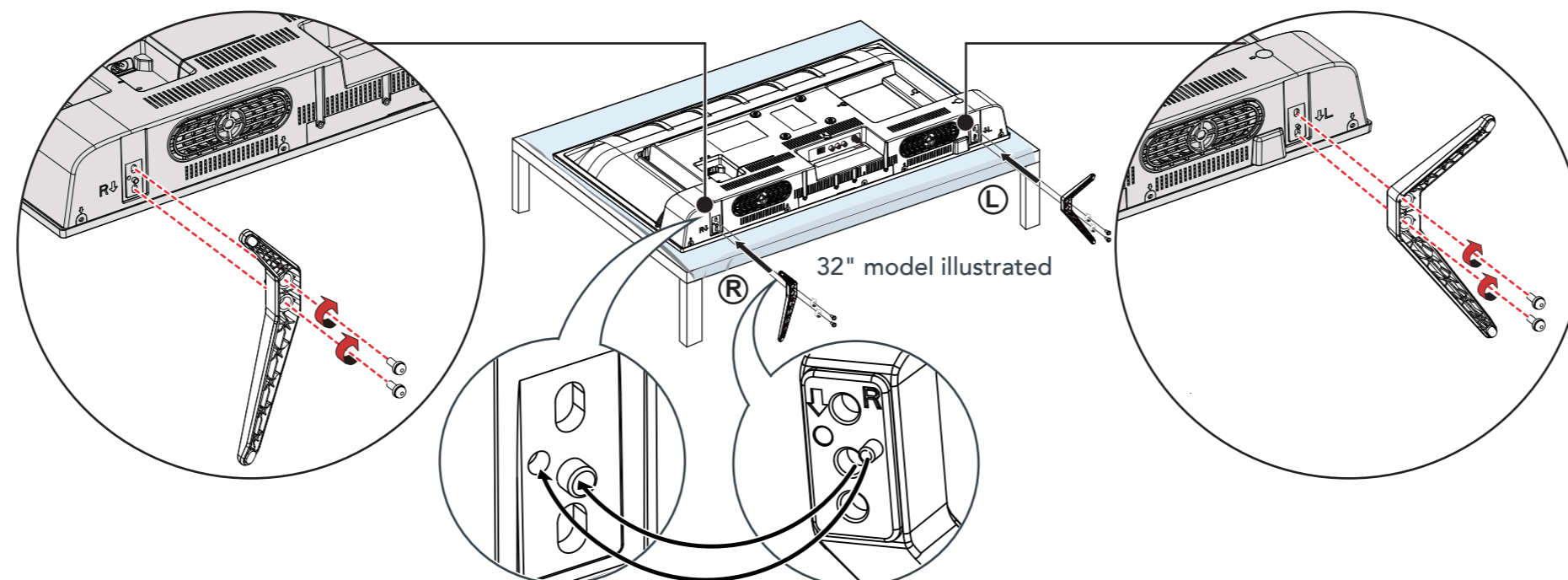

WALL MOUNT

How do I prepare my TV for wall mounting? (not for use with a TV stand)
 You'll need: Soft surface and a Phillips screwdriver.

Before you mount your TV, make sure that:

- You remove the stands.
- The bracket supports the weight of your TV.

Carefully place your TV face-down on a cushioned, clean surface.
 See the instructions that came with your wall mount for more information about how to correctly mount your TV.

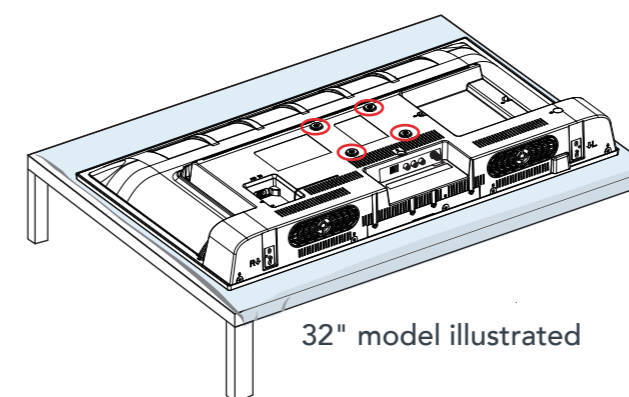

VESA Mounting Pattern

100 x 100 – M4 x 12 mm type screws (4 pcs)

Note: Wall-mount screws are not included.

Your TV has four VESA mounting holes on the back. If you attach a wall-mount bracket to the back of your TV, **the bracket must be securely attached using all four holes.** If you do not use all four mounting holes, your TV may fall and cause property damage or personal injury. See the documentation that came with your wall mount for complete mounting instructions.

FEATURES

Front

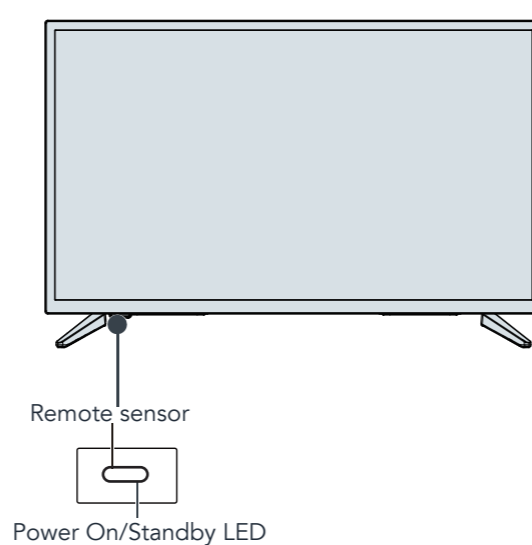

Back

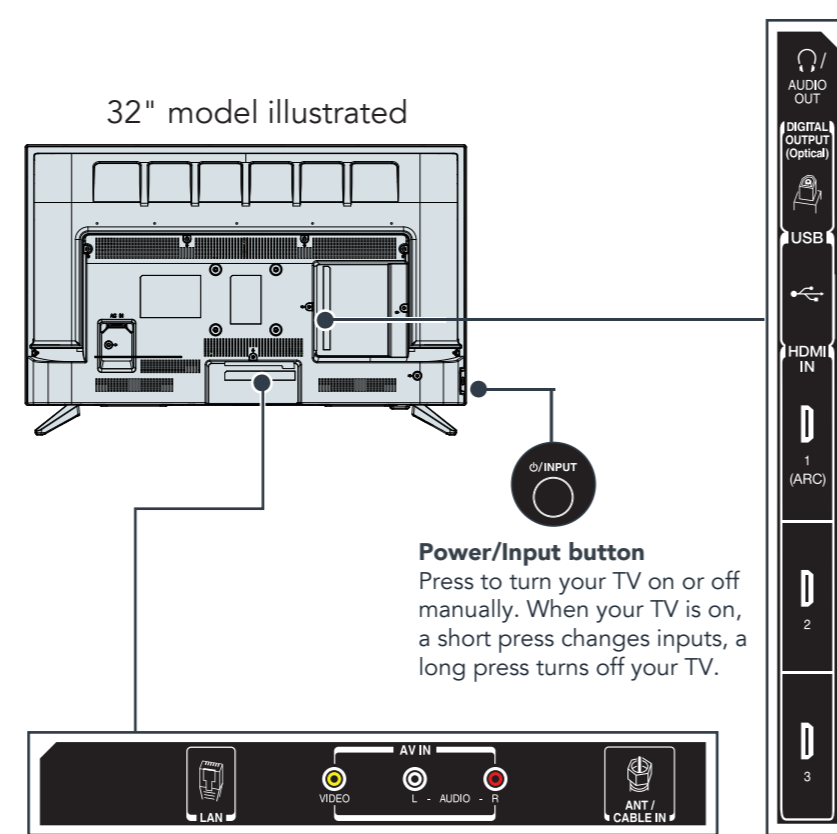

Power/Input button
 Press to turn your TV on or off manually. When your TV is on, a short press changes inputs, a long press turns off your TV.

Before using your new product, please read these instructions to prevent any damage.

2 MAKING CONNECTIONS

How do I watch TV (cable, satellite, or antenna) or connect a device such as a DVD or Blu-ray disc player or game console?
 How do I connect to the internet?

HDMI® (BEST)

Best video quality

Note: Connect an ARC-enabled home theater receiver to the **HDMI IN 1 (ARC)** jack.



HDMI options



Audio options

USING ANALOG AUDIO

USING DIGITAL AUDIO

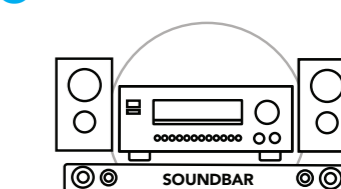

Note: See the instructions that came with your speakers or soundbar for more information.



COAXIAL (GOOD)

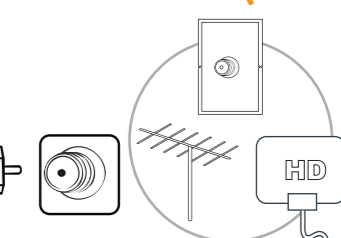

***Note:** Connect an HD antenna to access live, over-the-air TV.

ETHERNET (OPTIONAL)

Note: You have to connect either LAN or Wi-Fi to access the internet. See back for additional info.

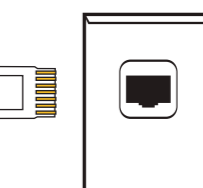

AV (GOOD)

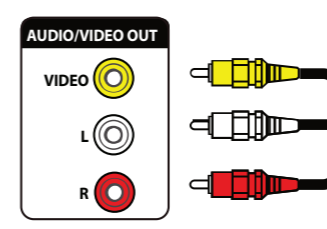
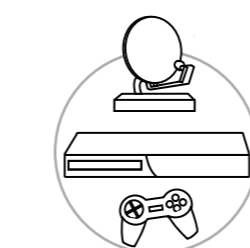

3 TURNING ON MY TV

When can I turn on my TV?

WHEN YOUR TV IS IN PLACE:

- 1 Plug the power cord into the **AC IN** jack on the back of your TV, then plug the other end into a power outlet.

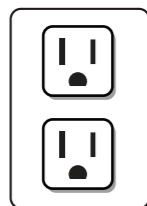

- 2 Remove the remote control cover and install the batteries.

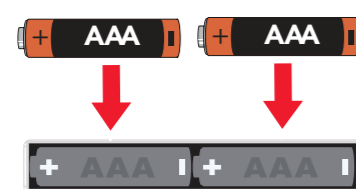

- 3 Press on your Voice Remote with Alexa.

- 4 Follow the on-screen instructions.

WARNING: To reduce the risk of fire or electric shock, do not expose this apparatus to rain or moisture.



The lightning flash with arrowhead symbol within an equilateral triangle is intended to alert the user to the presence of uninsulated "hazardous voltage" within the product's enclosure, which may be of sufficient magnitude to induce a risk of electric shock to persons.

The exclamation mark inside an equilateral triangle is intended to alert the user to the presence of important operating and maintenance (servicing) instructions in the literature accompanying the product or in the online User guide.

SERVICING

These servicing instructions are for use by qualified service personnel only. To reduce the risk of electric shock, do not perform any servicing other than that contained in the operating instructions unless you are qualified to do so.

AMAZON TERMS & POLICIES

Before using Fire TV Edition, please read the terms located at www.amazon.com/deviceservices/support. Please also read all terms and policies for services related to Fire TV Edition, including but not limited to Amazon's Privacy Notice located at www.amazon.ca/privacy, Amazon's Conditions of Use located at www.amazon.ca/conditionsofuse, and any other terms or usage provisions available at www.amazon.com/deviceservices/support. All terms, rules, notices, policies, and provisions are, collectively, the "Agreements." By using Fire TV Edition, you agree to be bound by the terms of the Agreements.

4 COMPLETE THE ON-SCREEN SETUP

Using your remote, follow the on-screen setup.

Your TV should automatically be paired to your new Voice Remote with Alexa.

- 1 If there are issues, you are prompted to pair your remote by pressing **Home**. If you continue to have issues, try re-inserting your batteries or replacing them.
- 2 Select your Wi-Fi network from the networks displayed on the screen.

Note: If your Wi-Fi network is password protected, have your Wi-Fi network password handy to connect your TV to the internet. If your network is hidden, select the **Join Other Network** tile. If required, enter your network password using the on-screen keyboard.

- 3 Select your experience: **Full** (Recommended) or **Basic**.

- **Full:** Get the most out of your experience with access to live TV, over 500,000 movies and TV episodes, thousands of apps, and Alexa skills. To get started, sign in or sign up for a free Amazon account.
- **Basic:** This experience is limited to live TV and only six streaming apps. Alexa and the full Appstore are not included.

5 OPTIONAL

(Watching live over-the-air TV)

If you connected your TV to an antenna or cable wall jack, complete the following steps:

- 1 When setup is complete, run a channel scan by going to **Settings > Live TV > Channel Scan**.
- 2 Follow the on-screen instructions to finish scanning for channels.
- 3 To browse and watch live over-the-air TV, use the **On Now** row or press the (guide) on your remote.

USING YOUR VOICE REMOTE WITH ALEXA

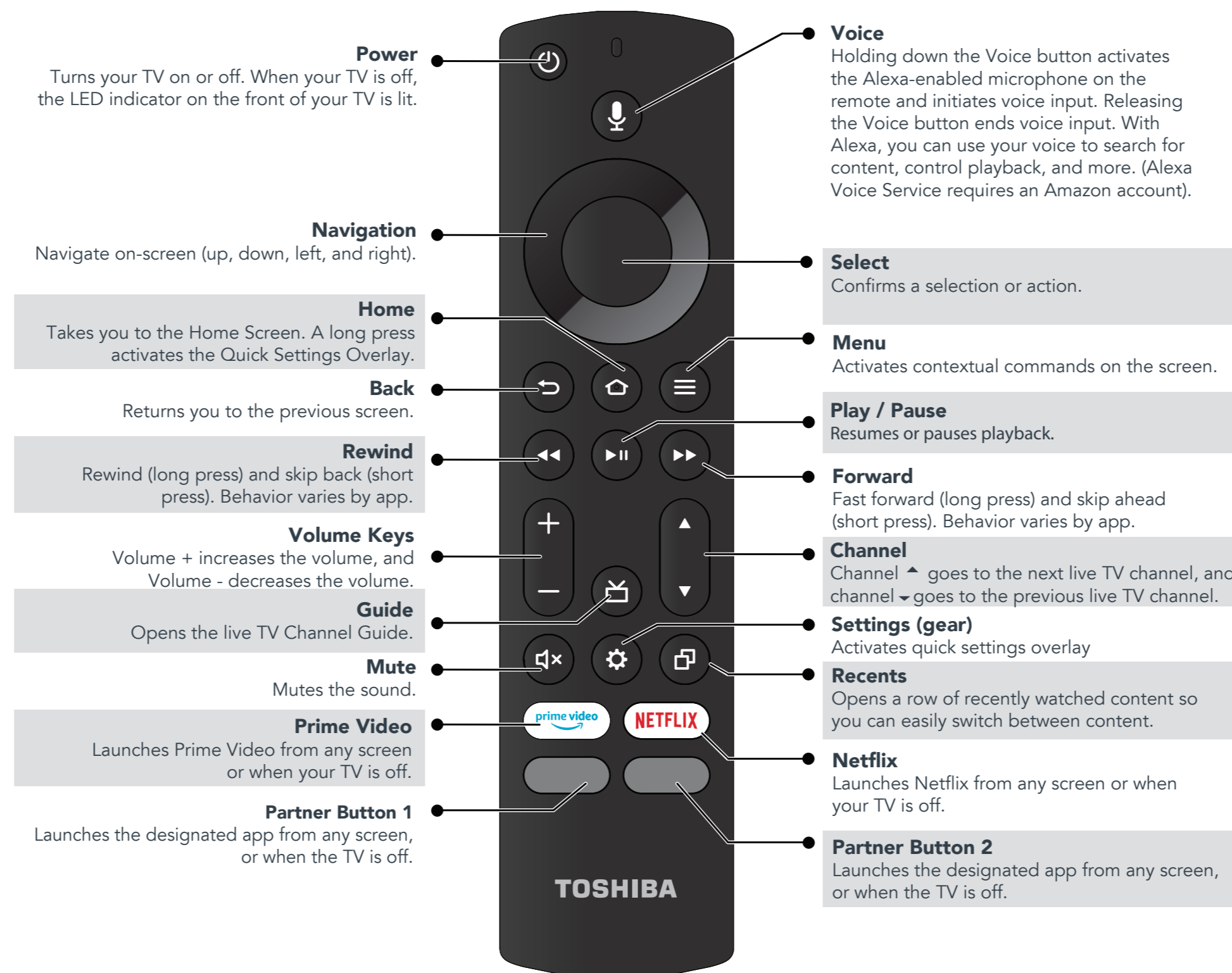

TOSHIBA

fire tv edition

A Smarter TV Is Here

HD Picture Quality, Fire TV Experience Built-In, Voice Remote with Alexa



Access Your Favorite Content – All Through One Home Screen

Fire TV Edition seamlessly integrates live over-the-air TV and streaming channels on a unified home screen



Endless Entertainment – Netflix, Prime Video, CTV, Crave and more

Watch tens of thousands of streaming movies and TV episodes with access to thousands of channels, apps, and Alexa skills



Control It All With Your Voice – Voice Remote with Alexa

Use your voice to watch live TV, launch apps, search for titles, play music, switch inputs, control smart home devices, and more

Full Experience required to access all features described.

Access the online User Guide

Go to www.tv.toshiba.com and search for your model number. Many questions regarding parts, service, and warranties can be answered by visiting the Support section of our website: www.tv.toshiba.com

Contact Toshiba Customer Support Center

1-855-527-2411 From the United States and Canada

Contact Amazon Fire TV Customer Service

www.amazon.com/deviceservices/support

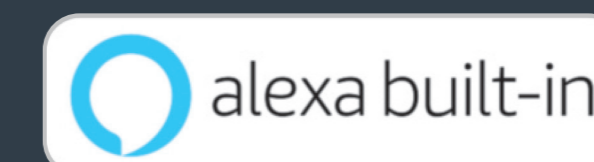

The Adopted Trademarks HDMI, HDMI High-Definition Multimedia Interface, and the HDMI Logo are trademarks or registered trademarks of HDMI Licensing Administrator, Inc. in the United States and other countries.

Manufactured under license from Dolby Laboratories. Dolby, Dolby Audio, and the double-D symbol are trademarks of Dolby Laboratories.

For DTS patents, see <http://patents.dts.com>. Manufactured under license from DTS, Inc. DTS, the Symbol, DTS and the Symbol together, and TruSurround are registered trademarks and/or trademarks of DTS, Inc. in the United States and/or other countries. DTS, Inc. All Rights Reserved.

Amazon, Fire, Alexa, Prime, and all related logos are trademarks of Amazon.com, Inc. or its affiliates.

Certain services are subject to change at any time, may not be available in all areas, and may require separate subscriptions.

Distributed and warranted by Best Buy Purchasing LLC
7601 Penn Avenue South, Richfield, MN 55423 USA

©2020 Best Buy. All rights reserved.