

TOSHIBA
Leading Innovation >>>

43"/49"/55" 1080p 60Hz LED TV

43L310U/49L310U/55L310U

Before using your new product, please read these instructions to prevent any damage.

Contents

CHILD SAFETY	1
Important Safety Instructions	2
WARNING	2
CAUTION	3
Introduction	5
HDMI®CEC Control	5
DTS TruSurround™	5
GameTimer™	5
Installing the stands or wall-mount bracket	6
Installing the stands (43-inch).....	6
Installing the stands (49-inch and 55-inch).....	7
Installing a wall-mount bracket	9
TV components	12
Package contents	12
Front	12
TV buttons	13
Side jacks	14
Back jacks	15
Remote control	16
What connection should I use?	17
Connecting a cable or satellite box	18
HDMI (best)	18
DVI (same as HDMI but requires an audio connection)	19
Component video (better)	20
AV (composite video) (good).....	21
Coaxial (good).....	22
Connecting an antenna or cable TV (no box)	23
Connecting a DVD or Blu-ray player	24
HDMI (best)	24
Component video (better)	25
AV (composite video) (good).....	26
Connecting a game console	27
HDMI (best)	27
Component video (better)	28
AV (composite video) (good).....	29

Connecting a computer	30
HDMI (best)	30
DVI (same as HDMI but requires an audio connection)	31
Connecting a USB flash drive	32
Connecting headphones	33
Connecting external speakers or a sound bar	34
Digital audio	34
Analog audio	35
Connecting a home theater system with multiple devices	36
Connecting power	37
Using the remote control	38
Installing remote control batteries	38
Aiming the remote control	38
Programming the CH RTN button	39
Turning on your TV for the first time	39
Setting up the video input jacks	40
Setting up the ANT / CABLE IN jack	40
Setting the RGB range for HDMI jacks	40
Understanding the basics	41
Turning your TV on or off	41
Selecting the video input source	41
On-screen menu overview	42
Navigating the menus	43
Adjusting the volume	43
Selecting a channel	43
Viewing channel information	44
Viewing HDMI information	44
Controlling CEC-compatible devices	45
Turning HDMI-CEC Control on or off	45
Turning TV Auto Power on or off	46
Turning Auto Standby on or off	46
Turning Amplifier Control on or off	47
Selecting the audio output	47
Using the TV remote to control CEC-compatible devices	48
Using the TV menu to control CEC-compatible devices	48
Using the Media Player	49
Supported photo file formats	49
Turning Auto Start on or off	49
Automatically opening the Media Player	49
Manually opening the Media Player	50
Viewing photos	50
Viewing photos in a slideshow	50

Adjusting the picture	51
Adjusting the TV picture	51
Adjusting the picture size	53
Scrolling the TheaterWide™ picture	54
Automatically adjusting the aspect ratio	54
Using the 4:3 Stretch	55
Freezing the picture	55
Adjusting the sound	55
Adjusting sound settings	55
Playing TV audio only	56
Using the Channel Browser	57
Channel Browser overview	57
Setting up the Channel Browser	57
Selecting a channel or input in the Channel Browser	58
Adding and clearing channels and inputs in the History list	58
Changing channel settings	59
Automatically scanning for channels	59
Manually adding channels to the channel list	60
Hiding channels	60
Setting up the Favorites list	61
Tuning to a favorite channel or input	61
Deleting a favorite channel or input	61
Setting parental controls	62
Setting a new PIN	62
Changing or deleting the PIN	62
Blocking TV programs and movies (for USA region)	63
Downloading rating information (for USA region)	64
Temporarily unlocking programs	65
Locking video inputs	65
Locking channels	66
Setting the GameTimer™	67
Locking control buttons on your TV	67
Using closed captioning	68
Turning closed captioning on or off	68
Selecting the analog closed captioning mode	68
Selecting the closed captioning mode with the C.CAPTION button	69
Customizing digital closed captioning settings	69
Adjusting time settings	70
Setting the time zone and Daylight Saving Time status	70
Setting the sleep timer	71
Adjusting menu settings	71
Selecting the menu language	71
Labeling a video input source	71

Maintaining	72
Cleaning the TV cabinet	72
Cleaning the TV screen	72
Troubleshooting	72
Viewing system information	73
Restoring settings to the defaults	73
Turning off the automatic power-off feature	74
Video and audio	74
Remote control	76
General	77
CEC-compatible devices	78
Specifications	80
43-inch (43L310U)	80
49-inch (49L310U)	81
55-inch (55L310U)	82
Legal notices	83
One-year limited warranty - Toshiba Televisions	84

CHILD SAFETY

PROPER TELEVISION PLACEMENT MATTERS



THE CONSUMER ELECTRONICS INDUSTRY CARES

- Manufacturers, retailers and the rest of the consumer electronics industry are committed to making home entertainment safe and enjoyable.
- As you enjoy your television, please note that all televisions - new and old - must be supported on proper stands or installed according to the manufacturer's recommendations. Televisions that are inappropriately situated on dressers, bookcases, shelves, desks, speakers, chests, carts, etc., may fall over, resulting in injury.

TUNE IN TO SAFETY

- **ALWAYS** follow the manufacturer's recommendations for the safe installation of your television.
- **ALWAYS** read and follow all instructions for proper use of your television.
- **NEVER** allow children to climb on or play on the television or the furniture on which the television is placed.
- **NEVER** place the television on furniture that can easily be used as steps, such as a chest of drawers.
- **ALWAYS** install the television where it cannot be pushed, pulled over or knocked down.
- **ALWAYS** route cords and cables connected to the television so that they cannot be tripped over, pulled or grabbed.

WALL OR CEILING MOUNT YOUR TELEVISION

- **ALWAYS** contact your retailer about professional installation if you have any doubts about your ability to safely mount your television.
- **ALWAYS** use a mount that has been recommended by the television manufacturer and has a safety certification by an independent laboratory (such as UL, CSA, ETL).
- **ALWAYS** follow all instructions supplied by the television and mount manufacturers.
- **ALWAYS** make sure that the wall or ceiling where you are mounting the television is appropriate. Some mounts are not designed to be mounted to walls and ceilings with steel studs or cinder block construction. If you are unsure, contact a professional installer.
- Televisions can be heavy. A minimum of two people is required for a wall or ceiling mount installation.

MOVING AN OLDER TELEVISION TO A NEW PLACE IN YOUR HOME

- Many new television buyers move their older CRT televisions into a secondary room after the purchase of a flat-panel television. Special care should be made in the placement of older CRT televisions.
- **ALWAYS** place your older CRT television on furniture that is sturdy and appropriate for its size and weight.
- **NEVER** place your older CRT television on a dresser where children may be tempted to use the drawers to climb.
- **ALWAYS** make sure your older CRT television does not hang over the edge of your furniture.

Important Safety Instructions

CAUTION

RISK OF ELECTRIC SHOCK

DO NOT OPEN

CAUTION: TO REDUCE THE RISK OF ELECTRIC SHOCK, DO NOT REMOVE COVER (OR BACK). NO USER-SERVICEABLE PARTS INSIDE. REFER SERVICING TO QUALIFIED SERVICE PERSONNEL.



The lightning flash with arrowhead symbol within an equilateral triangle is intended to alert the user to the presence of uninsulated "hazardous voltage" within the product's enclosure, which may be of sufficient magnitude to induce a risk of electric shock to persons.



The exclamation point within an equilateral triangle is intended to alert the user to the presence of important operating and maintenance (servicing) instructions in the literature accompanying the appliance.

- 1 Read these instructions.
- 2 Keep these instructions.
- 3 Heed all warnings.
- 4 Follow all instructions.
- 5 Do not use this apparatus near water.
- 6 Clean only with dry cloth.
- 7 Do not block any ventilation openings. Install in accordance with the manufacturer's instructions.
- 8 Do not install near any heat sources such as radiators, heat registers, stoves, or other apparatus (including amplifiers) that produce heat.
- 9 Do not defeat the safety purpose of the polarized or grounding-type plug. A polarized plug has two blades with one wider than the other. A grounding type plug has two blades and a third grounding prong. The wide blade or the third prong are provided for your safety. If the provided plug does not fit into your outlet, consult an electrician for replacement of the obsolete outlet.
- 10 Protect the power cord from being walked on or pinched particularly at plugs, convenience receptacles, and the point where they exit from the apparatus.
- 11 Only use attachments/accessories specified by the manufacturer.

- 12 Use only with the cart, stand, tripod, bracket, or table specified by the manufacturer, or sold with the apparatus. When a cart is used, use caution when moving the cart/apparatus combination to avoid injury from tip-over.



- 13 Unplug this apparatus during lightning storms or when unused for long periods of time.
- 14 Refer all servicing to qualified service personnel. Servicing is required when the apparatus has been damaged in any way, such as power-supply cord or plug is damaged, liquid has been spilled or objects have fallen into the apparatus, the apparatus has been exposed to rain or moisture, does not operate normally, or has been dropped.
- 15 The *wall plug* is the disconnecting device. The plug must remain readily operable.
- 16 Remote control batteries should not be exposed to excessive heat such as sunshine, fire, or the like.
- 17 The apparatus should not be exposed to dripping or splashing, and no objects filled with liquids, such as vases, should be placed on the apparatus.
- 18 Your TV has four VESA mounting holes on the back. If you attach a wall-mount bracket or TV stand to the back of your TV, **the bracket or stand must be securely attached using all four holes.** If you do not use all four mounting holes, your TV may fall and cause property damage or personal injury. See the documentation that came with your wall mount or TV stand for complete mounting instructions.

WARNING

Electric shock hazard

To reduce the risk of fire or electric shock, do not remove any cover or expose the device to rain or moisture. No user-serviceable parts are inside. Refer servicing to qualified service technicians.

Lightning

For added protection for your device receiver during a lightning storm, or when it is left unattended and unused for long periods of time, unplug it from the power outlet and disconnect any antenna or cable system. This helps prevent property damage and personal injury from lightning and power line surges.

Power lines

An outside antenna system should not be located in the vicinity of overhead power lines or other electric light or power circuits, or where it can fall into such power lines or circuits. When installing an outside antenna system, take extreme care to keep from touching such power lines or circuits as contact with them might be fatal.

Handling the LCD panel

- Your TV's screen is made of glass. Do not drop your TV or hit, jolt, or press hard against the LCD panel. If the screen breaks, be careful of broken glass.
- If the LCD panel is broken, make absolutely sure that you do not touch the liquid in the panel. This may cause skin inflammation.
- If the liquid gets in your mouth, immediately gargle, rinse, and consult with your doctor. Also, if the liquid gets in your eyes or touches your skin, consult with your doctor after rinsing for at least 15 minutes or longer in clean water.

Replacement parts

When replacement parts are required, make sure that the service technician uses replacement parts specified by the manufacturer that have the same characteristics as the original part. Unauthorized substitutions may result in fire, electric shock, personal injury, or other hazards.

Safety check

After completing any service or repair to this device, ask the service technician to perform routine safety checks to determine that your TV is in correct operating condition.

Power source

Operate your TV only from the type of power source indicated on the marking label. If you are not sure of the type of power supplied to your home, consult an electrician or your local power company.

Servicing

These servicing instructions are for use by qualified service personnel only. To reduce the risk of electric shock, do not perform any servicing other than that contained in the operating instructions unless you are qualified to do so.

CAUTION**Damage requiring service**

Unplug this TV from the power outlet and refer servicing to qualified service personnel under the following conditions:

- When the power supply cord or plug is damaged or frayed.
- If liquid has been spilled or objects have fallen into your TV.
- If your TV has been exposed to rain or water.
- If your TV does not operate normally by following the operating instructions. Adjust only those controls covered by the operating instructions because incorrect adjustment of other controls may result in damage and will often require extensive work by a qualified technician to restore your TV to its normal operation.
- If your TV has been dropped or damaged in any way.
- When your TV exhibits a distinct change in performance.

Outdoor antenna grounding

If an outside antenna or cable system is connected to your TV, make sure that the antenna or cable system is grounded to provide some protection against voltage surges and built-up static charges. Article 810 of the National Electrical Code, ANSI/NFPA No. 70, provides information with respect to correct grounding of the mast and supporting structure, grounding of the lead-in wire to an antenna discharge unit, size of grounding conductors, location of the antenna-discharge unit, connection to grounding electrodes, and requirements for the grounding electrode.

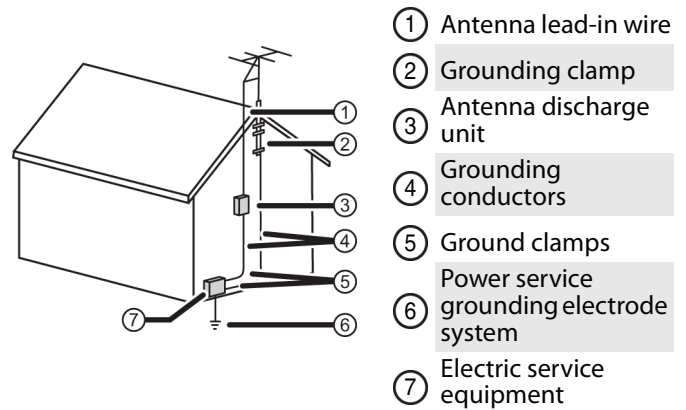
**Note to CATV system installer**

Article 820 of the National Electrical Code, ANSI/NFPA No. 40 provides guidance for correct grounding. Specifically, it states that the cable ground must be connected to the grounding system of the building as close to the point of cable entry as practical.

Condensation

Moisture will form on the TV if the TV is brought from cool surroundings into a warm room or if the temperature of the room rises suddenly. When this happens, the TV's performance may be impaired. To prevent this, let the TV stand in its new surroundings for about an hour before switching it on, or make sure that the room temperature rises gradually.

Condensation may also form during the summer if the TV is exposed to the breeze from an air conditioner. In such cases, change the location of the TV.

Mobile telephone warning

To avoid interference with your TV picture and sound, operating problems, or even damage, keep your cordless and cellular telephones away from the TV.

End of life directives

Your TV may contain materials that are regulated for environmental reasons. Your TV also contains materials that can be recycled and reused. To help protect the environment, contact your local authorities for information about disposal or recycling and about finding a recycler in your area before you dispose of your TV.

California Proposition 65

Warning: This product contains chemicals known to the State of California to cause cancer and birth defects or other reproductive harm. Wash hands after handling.

Non-active pixels

The LCD panel contains almost 3 million thin film transistors, which provide exceptionally sharp video quality. Occasionally, a few non-active pixels may appear on the screen as a fixed blue, green, or red point. These non-active pixels do not adversely affect the performance of your TV, and are not considered defects.

Toshiba 43"/49"/55" 1080p 60Hz LED TV

Introduction

Congratulations on your purchase of a high-quality Toshiba product. Your 43L310U, 49L310U, or 55L310U represents the state of the art in LED TV design and is designed for reliable and trouble-free performance.

HDMI®CEC Control

Enjoy the benefit of having HDMI CEC compatible products plug and play! No setup is needed! CEC technology lets different devices discover and communicate with each other. (See page 45 for instructions on how to use HDMI® CEC Control.)

DTS TruSurround™

DTS TruSurround delivers clear, crisp, and natural sound while providing deep enveloping bass.

GameTimer™

Use the GameTimer™ to set a time limit for playing a video game (from 30 to 120 minutes). When the GameTimer expires, your TV locks out the input source for the video game device.

Installing the stands or wall-mount bracket

- If you want to place your TV on a table or in an entertainment center, go to [Installing the stands \(43-inch\)](#) or [Installing the stands \(49-inch and 55-inch\)](#).
- If you want to mount your TV on a wall, go to [Installing a wall-mount bracket](#).

Notes

- If you plan to wall-mount your TV, do not install the stands.
- Store the stands and stand screws in case you decide to use the stand in the future.

Installing the stands (43-inch)

- 1 Carefully place your TV face-down on a cushioned, clean surface to protect the screen from damages and scratches.

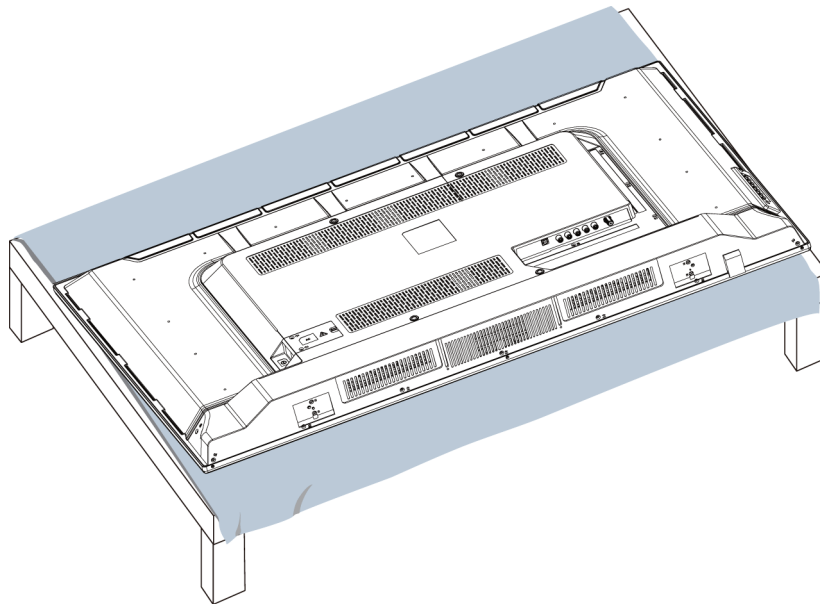

2 Secure each TV stand leg to the bottom of your TV with two of the provided screws.

Screw type	Screw length	# of screws
M5	25 mm	4

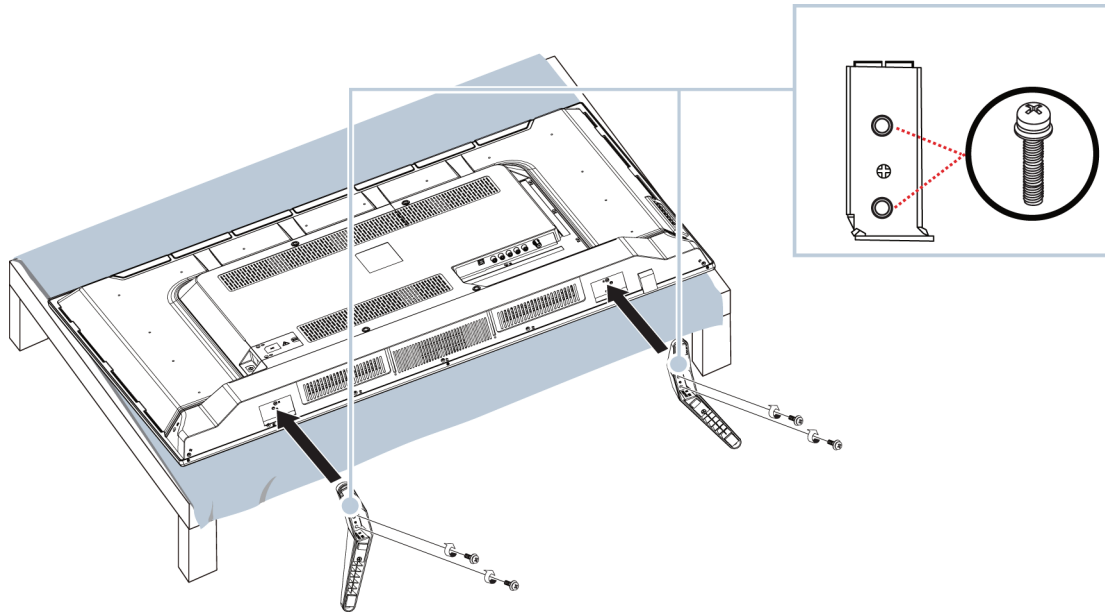

Installing the stands (49-inch and 55-inch)

1 Carefully place your TV face-down on a cushioned, clean surface to protect the screen from damages and scratches.

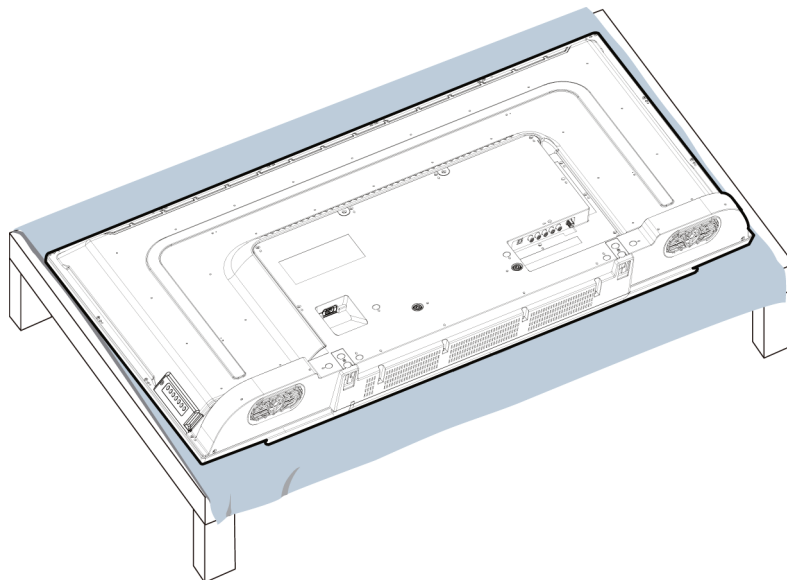

- 2 Secure each TV stand to the bottom of your TV with two of the provided screws.

Screw type	Screw length	# of screws
M5	10 mm	4

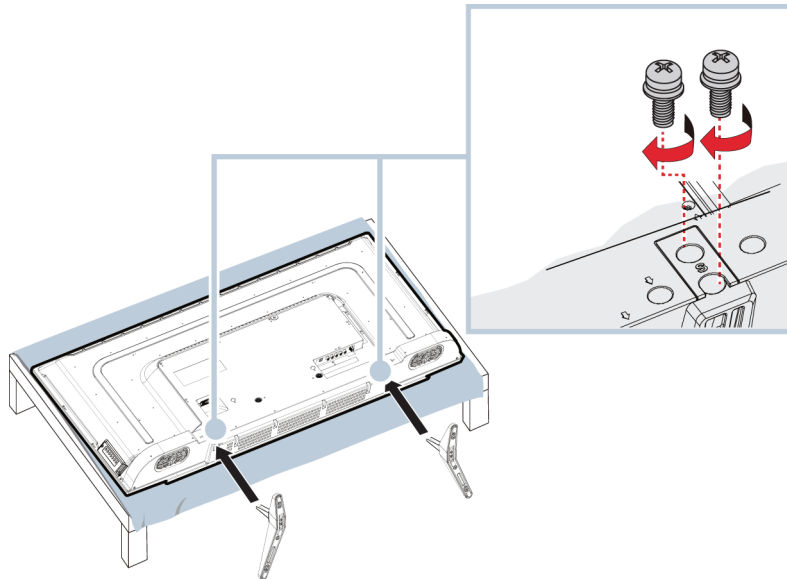

Installing a wall-mount bracket

Warning

- Your TV has four VESA mounting holes on the back. If you attach a wall-mount bracket to the back of your TV, **the bracket must be securely attached, using all four holes.** If you do not use all four mounting holes, your TV may fall and cause property damage or personal injury. See the documentation that came with your wall mount for complete mounting instructions.
- This TV is intended to be supported by a UL Listed wall mount bracket with suitable weight/load. (See [Miscellaneous](#) on page 80, 81, or 82.)

- 1 Carefully place your TV face-down on a cushioned, clean surface to protect the screen from damages and scratches.

43-inch

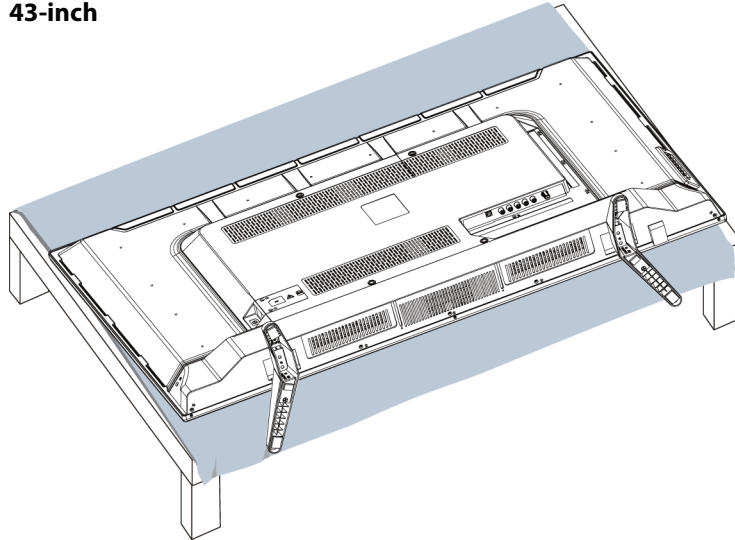

49-inch and 55-inch

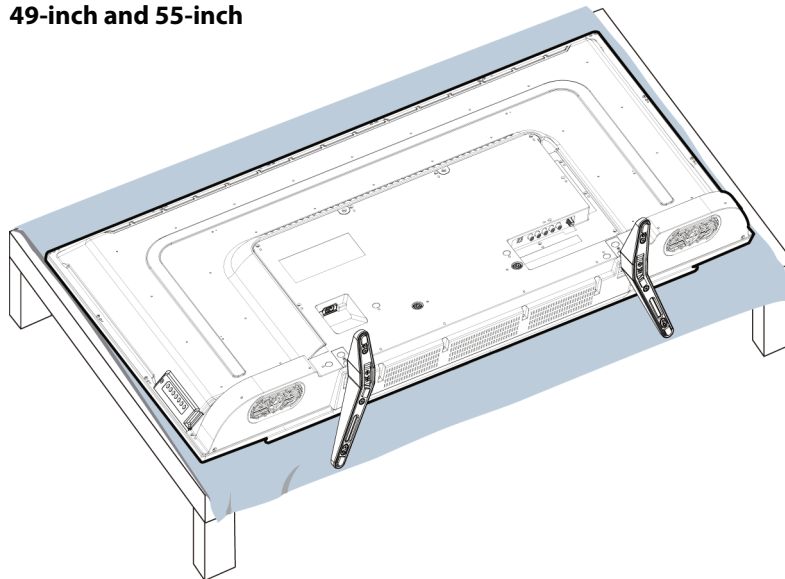

- 2 If the stands are installed, remove the two screws that secure each stand to your TV, then remove the stands.

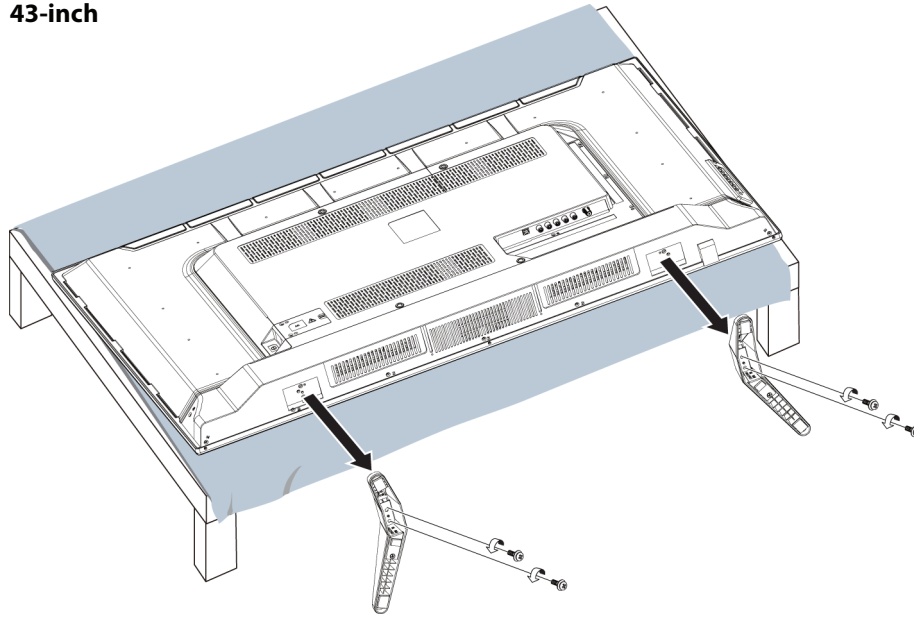
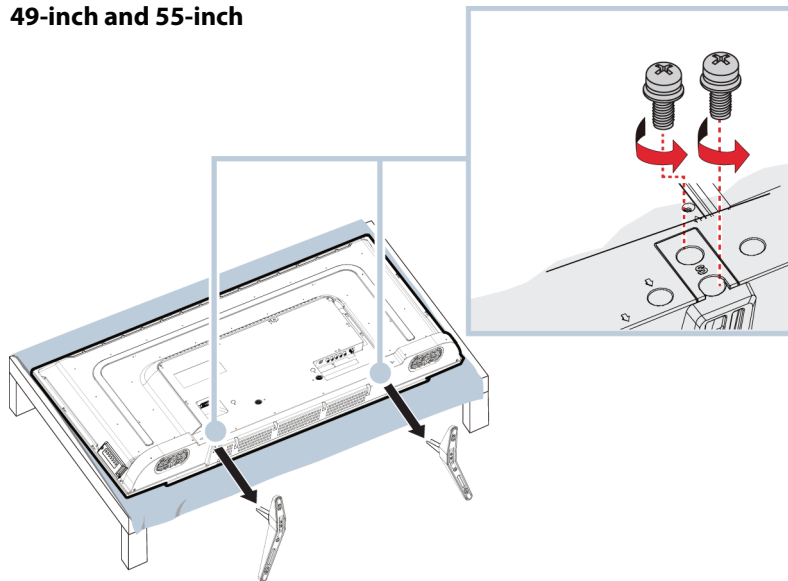
43-inch**49-inch and 55-inch**

- 3 See the instructions that came with the wall-mount bracket for information about which screws to use and how to correctly hang your TV.

Notes

- The length of the wall-mount screws vary depending on the wall-mount bracket you purchased. See the instructions that came with the wall-mount bracket for screw lengths.
- The mounting holes on the back of your TV take type M6 screws.

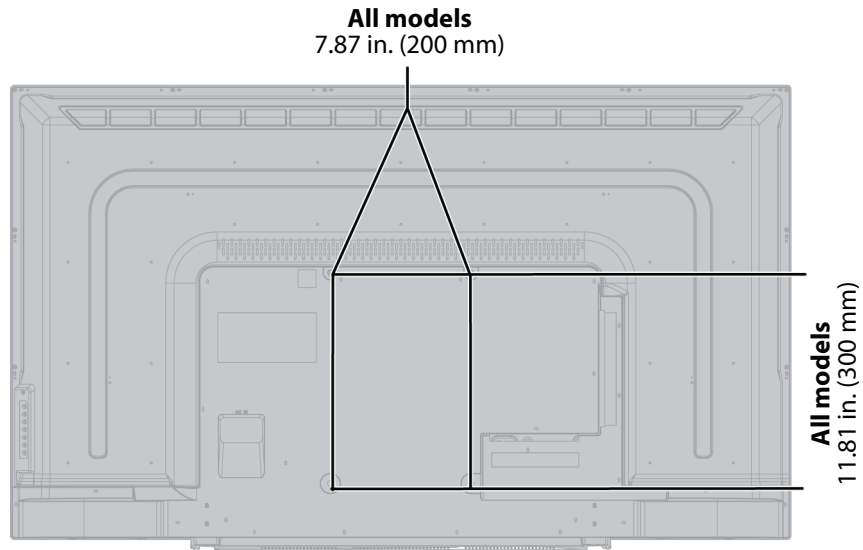

TV components

This section contains information about:

- Package contents
- Front
- TV buttons
- Side jacks
- Back jacks
- Remote control

Package contents

- 43-inch, 49-inch, or 55-inch LED TV
- Remote control and batteries (2 AAA)
- TV stand legs (2) and screws (4)
- Power cord
- *Quick Setup Guide*
- *Important Information*

Front

43-inch model

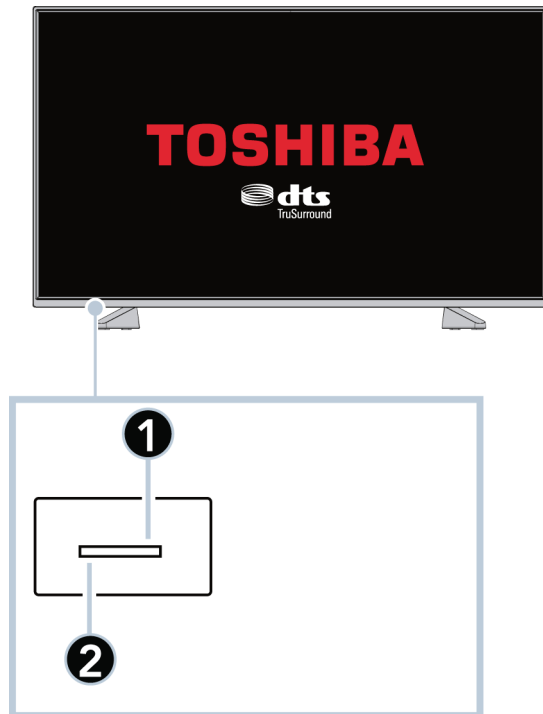

49-inch and 55-inch

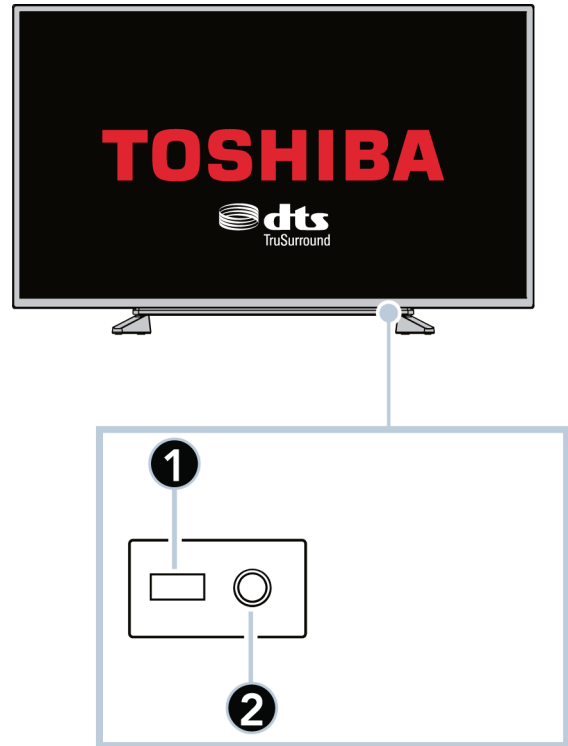

#	Item	Description
1	Remote control sensor	Receives signals from the remote control. Do not block.
2	Power indicator	Turns off when your TV is on. Lights red when your TV is off (standby mode).

TV buttons

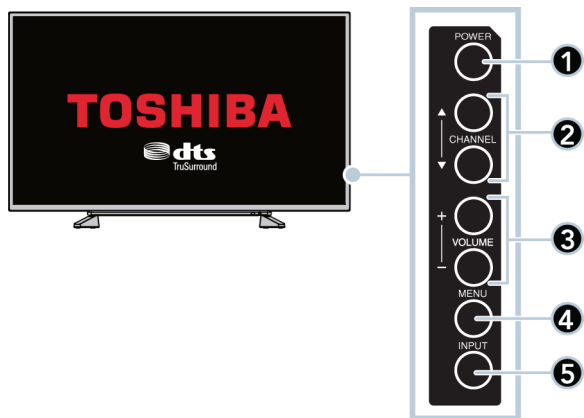

#	Item	Description
1	POWER	<p>Press to turn your TV on or off (standby mode).</p> <p>Warning: When your TV is off, power still flows through it. To completely disconnect power, unplug the power cord.</p>
2	CHANNEL ▲/▼	<p>Press to go to the next or previous channel in the channel list. For more information, see Selecting a channel on page 43.</p> <p>OR</p> <p>Press to select an option in an on-screen menu.</p>
3	VOLUME +/-	<p>Press to increase or decrease the volume.</p> <p>OR</p> <p>Press to go to the next or previous menu in the on-screen menus.</p>
4	MENU	<p>Press to open the on-screen menu. For more information, see Navigating the menus on page 43.</p>
5	INPUT	<p>Press to open the <i>Input Selection</i> list, then press:</p> <ul style="list-style-type: none"> • INPUT one or more times to select the video input source. • ▲ or ▼ to highlight the video input source, then press ENTER. • The number button for the video input source. <p>For more information, see Selecting the video input source on page 41.</p>

Side jacks

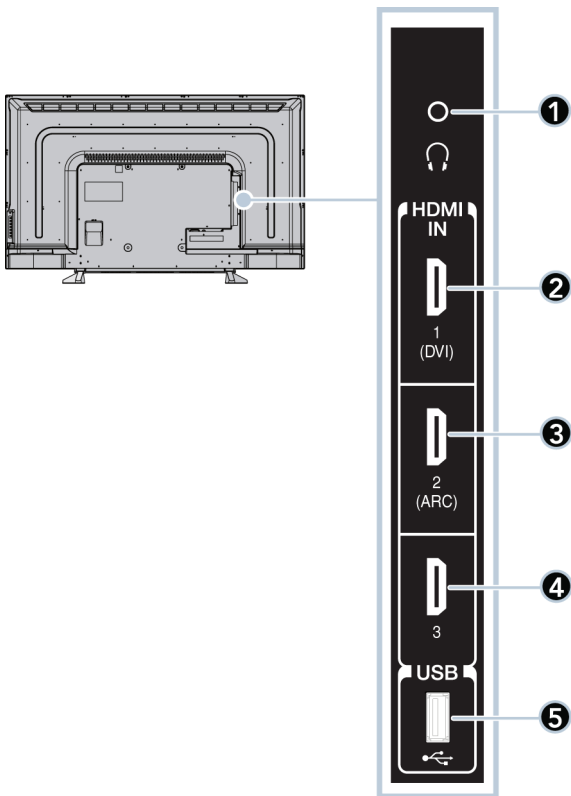

#	Item	Description
1	🎧	<p>Connect headphones to this jack. See Connecting headphones on page 33.</p> <p>OR</p> <p>Connect an analog sound bar, speaker system, or home theater system to this jack to listen to TV audio through external speakers. For more information, see Analog audio on page 35.</p>
2	HDMI IN 1 (DVI)	<p>Connect an HDMI device to this jack. For more information, see HDMI (best) on page 18, 24, 27, or 30.</p> <p>OR</p> <p>Connect the video for a DVI device to this jack. For more information, see DVI (same as HDMI but requires an audio connection) on page 19 or 31.</p>
3	HDMI IN 2 (ARC)	<p>Connect an HDMI device to this jack. For more information, see HDMI (best) on page 18, 24, 27, or 30.</p> <p>OR</p> <p>Connect an ARC-enabled home theater receiver to this jack.</p>
4	HDMI IN 3	<p>Connect an HDMI device to this jack. For more information, see HDMI (best) on page 18, 24, 27, or 30.</p>
5	USB	<p>Connect a USB flash drive to this jack to view compatible JPEG picture files. For more information, see Connecting a USB flash drive on page 32 and Using the Media Player on page 49.</p>

Back jacks

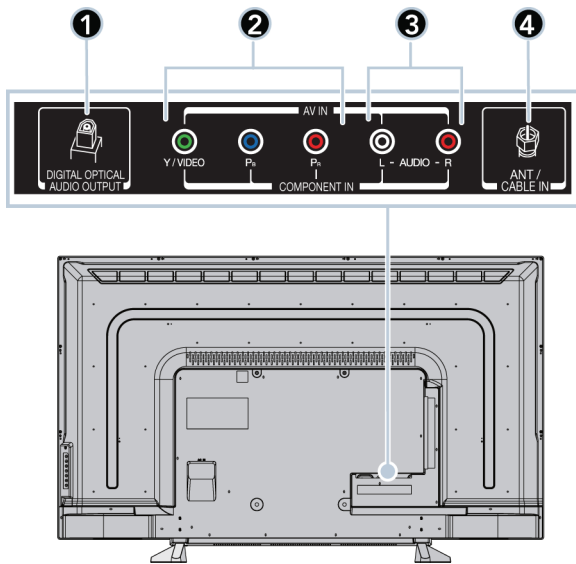

#	Item	Description
1	DIGITAL OPTICAL AUDIO OUT	Connect a sound bar, digital speaker system, or home theater system to this jack to listen to TV audio through external speakers. For more information, see Connecting external speakers or a sound bar on page 34.
2	Y/VIDEO, PB, PR OR VIDEO/Y	<p>The component video and AV jacks are shared. You can connect only one component video or AV device at a time.</p> <p>Connect the video for a component video device to the Y/VIDEO, PB, PR jacks. For more information, see Component video (better) on page 20, 25, or 28.</p> <p>OR</p> <p>Connect the video for an AV device to the Y/VIDEO jack. For more information, see AV (composite video) (good) on page 21, 26, or 29.</p>
3	AUDIO L and R	<p>Connect the audio for a component video device to these jacks. For more information, see Component video (better) on page 20, 25, or 28.</p> <p>OR</p> <p>Connect the audio for an AV device to these jacks. For more information, see AV (composite video) (good) on page 21, 26, or 29.</p>
4	ANT/CABLE IN	Connect an antenna or cable TV to this jack. For more information, see Coaxial (good) on page 22 or Connecting an antenna or cable TV (no box) on page 23.

Remote control

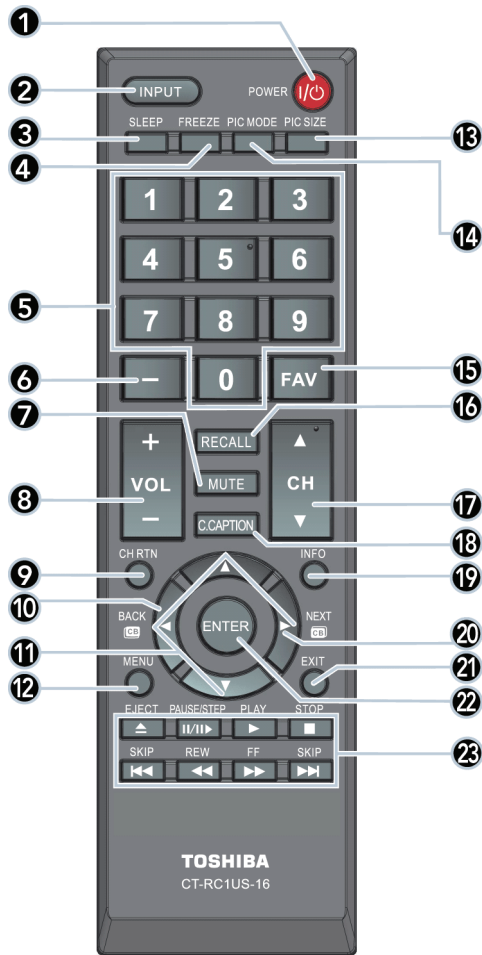



#	Button	Press to...
10	BACK CB	Open the channel browser and tune to the previous channel in the channel history. See Using the Channel Browser on page 57.
11	▲ ▼ ◀ ▶	TV —Navigate in on-screen TV menus and to adjust settings. USB —Control a photo slideshow.
12	MENU	Open the on-screen menu.
13	PIC SIZE	Change how the picture looks on the screen (aspect ratio). See Adjusting the picture size on page 53.
14	PIC MODE	Select the picture mode. You can select Dynamic , Standard , Movie , Game , or PC . See the Picture Mode option in Adjusting the TV picture on page 51.
15	FAV	Open the <i>Favorite</i> channel list. See Setting up the Favorites list on page 61 and Tuning to a favorite channel or input on page 61.
16	RECALL	Display TV status information.
17	CH▲/CH▼	Change TV channels. See Selecting a channel on page 43.
18	C.CAPTION	Turn closed captioning on or off. Select the language (like English) to turn on closed captioning or Off to turn off closed captioning. See Turning closed captioning on or off on page 68.
19	INFO	Display TV status information, such as the channel number, channel name (if available), or signal source. See Viewing channel information on page 44.
20	NEXT CB	Open the channel browser and tune to the next channel in the channel history. See Using the Channel Browser on page 57.
21	EXIT	Close the on-screen TV menu.
22	ENTER	Confirm selections or changes in on-screen menus.
23	Media Controls	HDMI CEC Control —Control HDMI CEC-compatible devices. See Controlling CEC-compatible devices on page 45. USB —Control a photo slideshow. See Using the Media Player on page 49.

#	Button	Press to...
1	I/⏻ (power)	Turn your TV on or off (standby mode). When your TV is off, the power indicator lights red. Warning: When your TV is off, power still flows through it. To disconnect power, unplug the power cord.
2	INPUT	Open the <i>Input Selection</i> list. Press ▲ or ▼ to select the video input source, then press ENTER . See Selecting the video input source on page 41.
3	SLEEP	Set the sleep timer. Each time you press this button, the sleep time increases by 10 minutes. See Setting the sleep timer on page 71.
4	FREEZE	Freeze the picture. Press again to un-freeze the picture. See Freezing the picture on page 55.
5	Numbers	Enter channel numbers and PINs.
6	—	Enter a digital sub-channel number. See Selecting a channel on page 43.
7	MUTE	Mute the sound or un-mute the sound. See Adjusting the volume on page 43.
8	VOL+/-	Increase or decrease the volume.
9	CH RTN	Return to the previous channel or source.

What connection should I use?

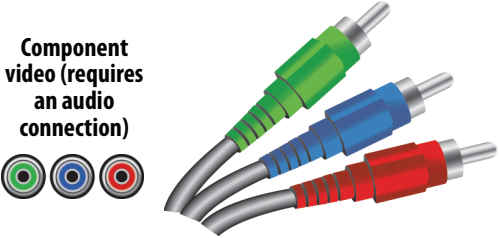
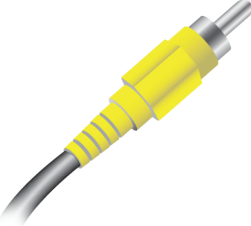
Your TV has several connection types for connecting devices to your TV.
 For the best video quality, you should connect a device to the best available connection.
 Use the following tables to identify cables:

Video quality	Connection type and jack	Cable connector
Best (use this if your devices have HDMI)	HDMI video/audio	
Better than composite or coaxial	Component video (requires an audio connection)	
Better than coaxial	AV (requires an audio connection)	
Good	Coaxial video/audio	

Connection type and jack

Cable connectors

Optical digital audio output



Analog audio input

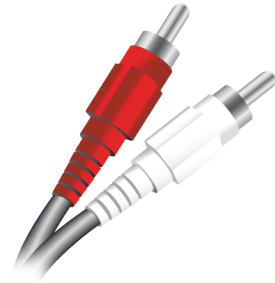

3.5mm analog audio output



You can use the **HDMI IN 1 (DVI)** jack on your TV to connect a DVI device to your TV. For more information, see [DVI \(same as HDMI but requires an audio connection\)](#) on page 19 or 31.

Cautions

- Check the jacks for position and type before making any connections.
- Loose connections can cause poor audio or video quality. Make sure that all connections are tight and secure.
- The external audio/video equipment shown may be different from your equipment. If you have questions, refer to the documentation that came with your equipment.
- Always unplug the power cord when connecting external equipment.

Connecting a cable or satellite box

Many cable or satellite TV boxes have more than one connection type. To get the best video, you should use the best connection type available. For more information, see [What connection should I use?](#) on page 17.

You can connect a cable or satellite box using:

- HDMI (best)
- DVI (same as HDMI but requires an audio connection)
- Component video (better)
- AV (composite video) (good)
- Coaxial (good)

HDMI (best)

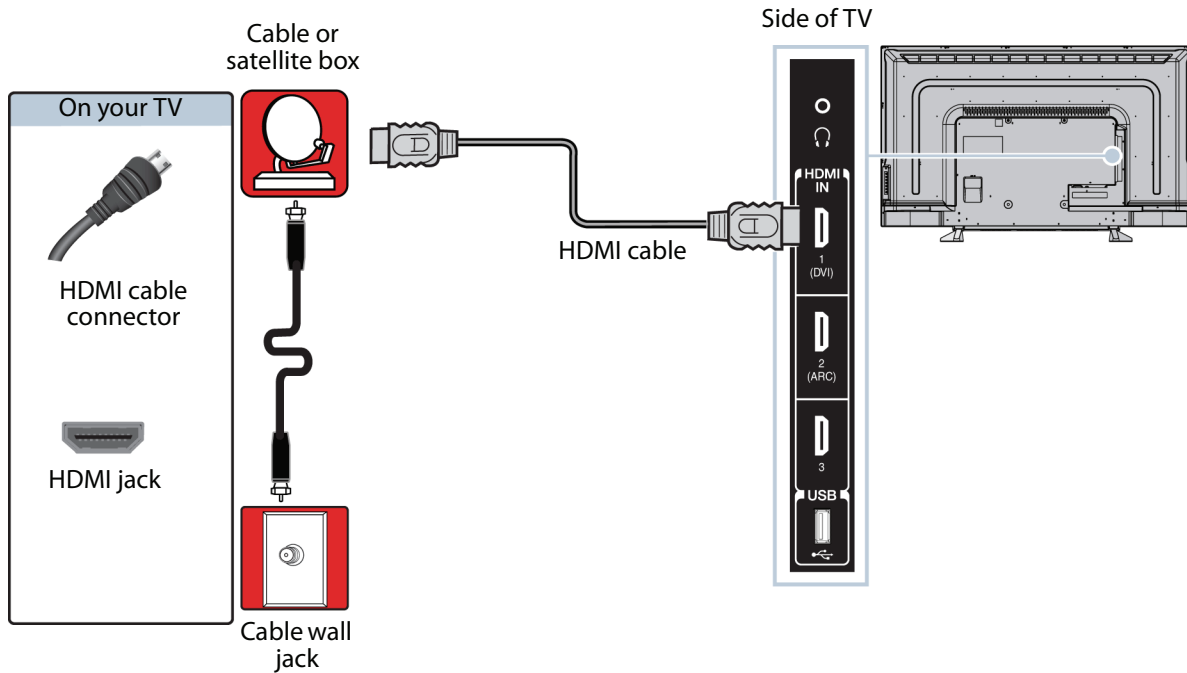

- 1 Make sure that your TV's power cord is unplugged and all connected equipment is turned off.
- 2 Connect the incoming cable from the cable wall jack to the cable-in jack on the cable or satellite box.
- 3 Connect an HDMI cable (not provided) to one of the **HDMI IN** jacks on the side of your TV and to the **HDMI OUT** jack on the cable or satellite box.
- 4 Plug your TV's power cord into a power outlet, turn on your TV, then turn on the cable or satellite box.
- 5 Press **INPUT** to open the *Input Selection* list.
- 6 Press **▲** or **▼** to highlight **HDMI 1**, **HDMI 2**, or **HDMI 3**, then press **ENTER**.

Note

An HDMI cable carries both audio and video. You do not need to use any audio cables.

DVI (same as HDMI but requires an audio connection)**Notes**

- You must use the **HDMI IN 1 (DVI)** jack to connect a cable box using DVI.
- Your TV supports DVI video only. To add sound for a DVI connection, connect external speakers or a sound bar to the cable or satellite box.

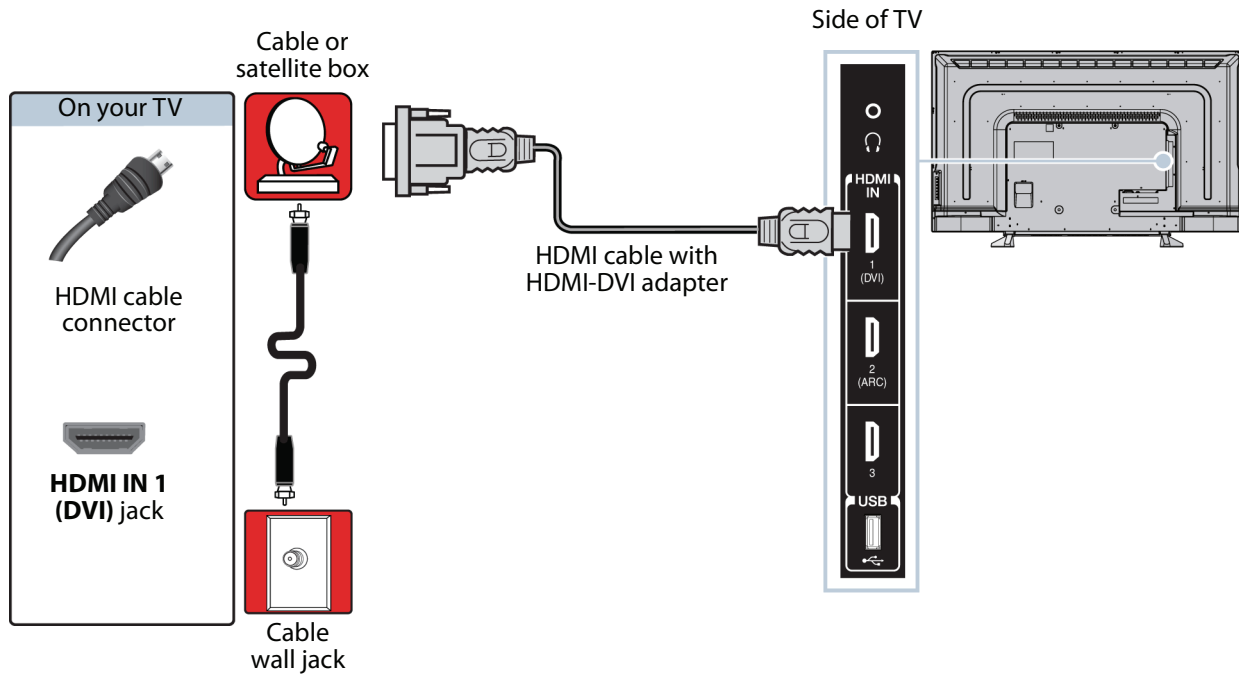

- 1 Make sure that your TV's power cord is unplugged and all connected equipment is turned off.
- 2 Connect the incoming cable from the cable wall jack to the cable-in jack on the cable or satellite box.
- 3 Connect an HDMI-DVI adapter (not provided) to one end of an HDMI cable (not provided), then connect the adapter to the **DVI OUT** jack on the cable or satellite box.
- 4 Connect the other end of the cable to the **HDMI IN 1 (DVI)** jack on the side of your TV.
- 5 Plug your TV's power cord into a power outlet, turn on your TV, then turn on the cable or satellite box.
- 6 Press **INPUT** to open the *Input Selection* list.
- 7 Press **▲** or **▼** to highlight **HDMI 1**, then press **ENTER**.

Component video (better)

Note
Cables are often color-coded to match color-coded jacks.

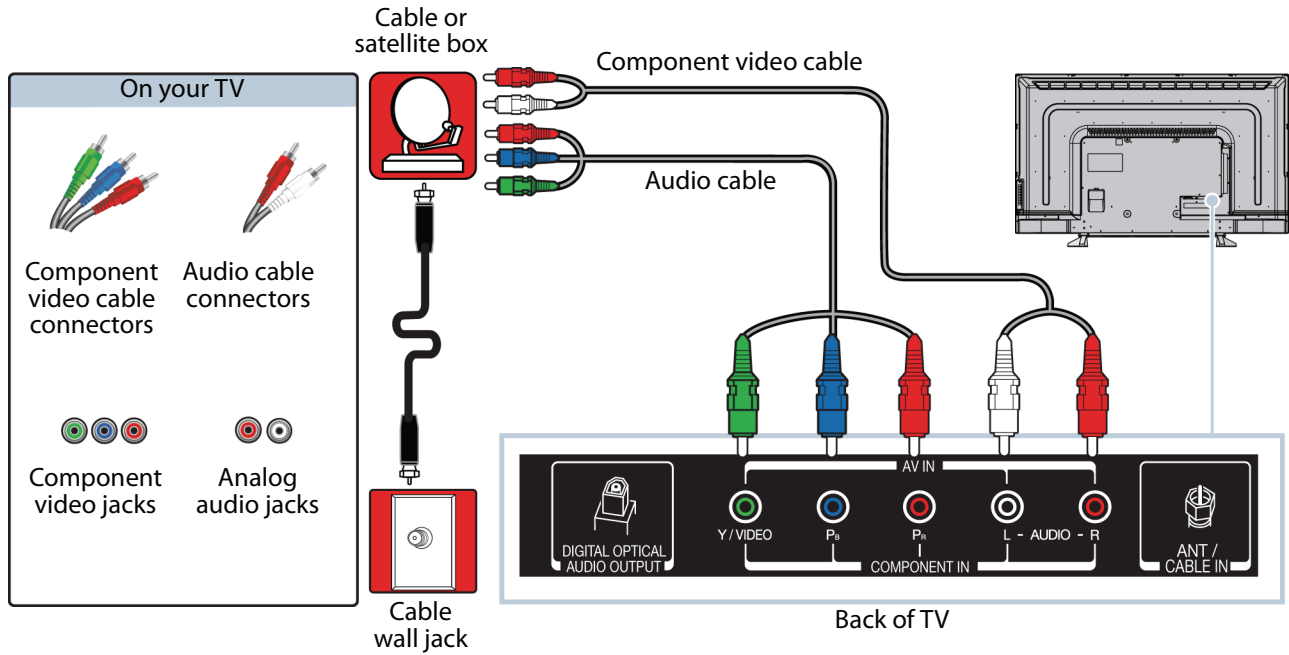

- 1 Make sure that your TV's power cord is unplugged and all connected equipment is turned off.
- 2 Connect the incoming cable from the cable wall jack to the cable-in jack on the cable or satellite box.
- 3 Connect a component video cable (not provided) to the **Y/VIDEO**, **Pb**, and **Pr** jacks on the back of your TV and the component video out jacks on the cable or satellite box.
- 4 Connect an audio cable (not provided) to the **AUDIO L** and **R** jacks on the back of your TV and to the audio out jacks on the cable or satellite TV box.

Important

- The **Y/VIDEO**, **Pb**, and **Pr** video jacks (used to connect a component device) share the **AUDIO L** and **R** jacks with the **Y/VIDEO** jack (used to connect an AV device). You can only connect one component video or AV device at a time. We suggest upgrading to HDMI if your cable or satellite box supports it.
- When you connect the audio using the **AUDIO L** and **R** jacks, the audio output is analog.

- 5 Plug your TV's power cord into a power outlet, turn on your TV, then turn on the cable or satellite box.
- 6 Press **INPUT** to open the *Input Selection* list.
- 7 Press **▲** or **▼** to highlight **COMPONENT**, then press **ENTER**.

AV (composite video) (good)**Notes**

- Cables are often color-coded to match color-coded jacks.
- The yellow video connector on the AV cable connects to the green **Y/VIDEO** jack.

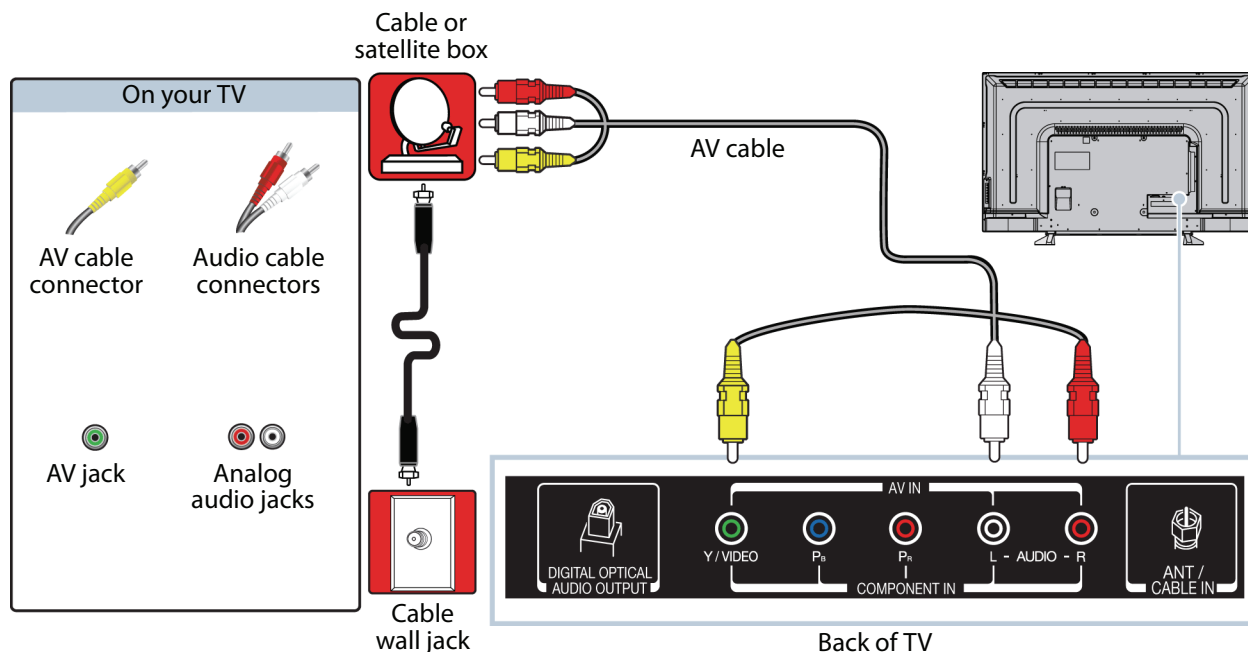

- 1 Make sure that your TV's power cord is unplugged and all connected equipment is turned off.
- 2 Connect the incoming cable from the cable wall jack to the cable-in jack on the cable or satellite box.
- 3 Connect an AV cable (not provided) to the green **Y/VIDEO** jack and **AUDIO L** and **R** jacks on the back of your TV and to the AV and audio out jacks on the cable or satellite box.

Important

- The **Y/VIDEO**, **Pb**, and **Pr** video jacks (used to connect a component device) share the **AUDIO L** and **R** jacks with the **Y/VIDEO** jack (used to connect an AV device). You can only connect one component video or AV device at a time. We suggest upgrading to HDMI if your cable or satellite box supports it.
- When you connect the audio using the **AUDIO L** and **R** jacks, the audio output is analog.

- 4 Plug your TV's power cord into a power outlet, turn on your TV, then turn on the cable or satellite box.
- 5 Press **INPUT** to open the *Input Selection* list.
- 6 Press **▲** or **▼** to highlight **AV**, then press **ENTER**.

Coaxial (good)

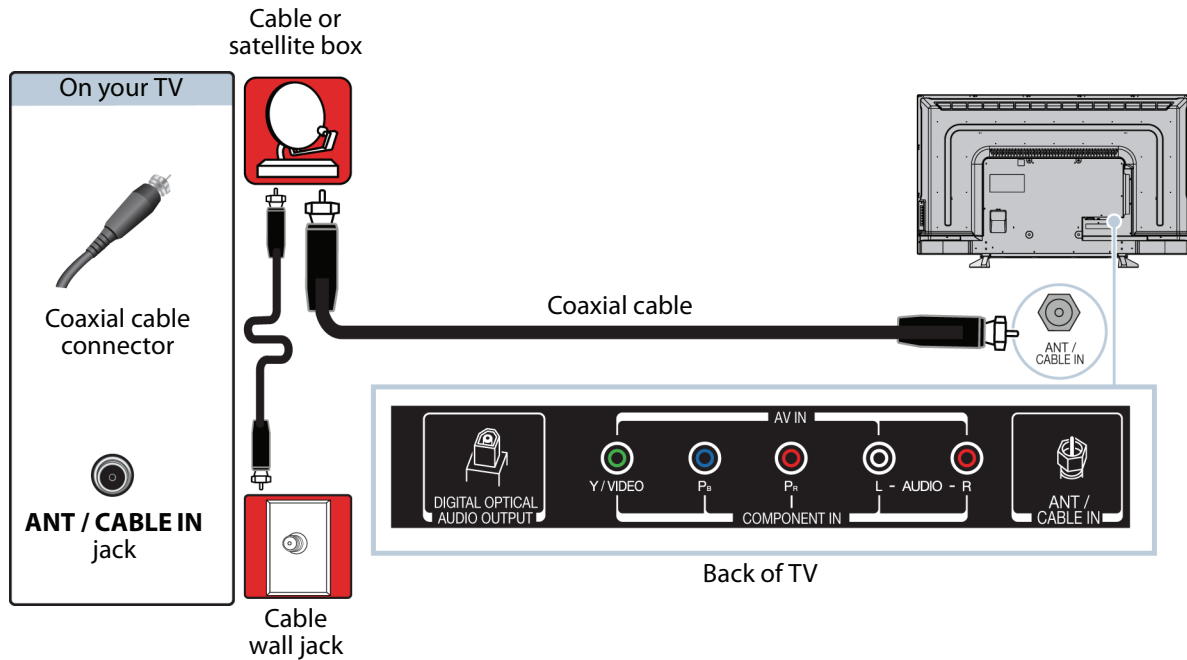

- 1 Make sure that your TV's power cord is unplugged and all connected equipment is turned off.
- 2 Connect the incoming cable from the cable wall jack to the cable-in on the cable or satellite box.
- 3 Connect a coaxial cable (not provided) to the **ANT / CABLE IN** jack on the back of your TV and to the coaxial out jack on the cable or satellite box.
- 4 Plug your TV's power cord into a power outlet, turn on your TV, then turn on the cable or satellite box.
- 5 Press **INPUT** to open the *Input Selection* list.
- 6 Press **▲** or **▼** to highlight **ANT / CABLE**, then press **ENTER**.
- 7 If you cannot tune to channels you know exist, scan for channels. See [Automatically scanning for channels](#) on page 59.

Notes

- Use a coaxial cable to eliminate interference and noise from radio waves.
- Do not bundle the coaxial cable with the power cord or other cables.

Connecting an antenna or cable TV (no box)

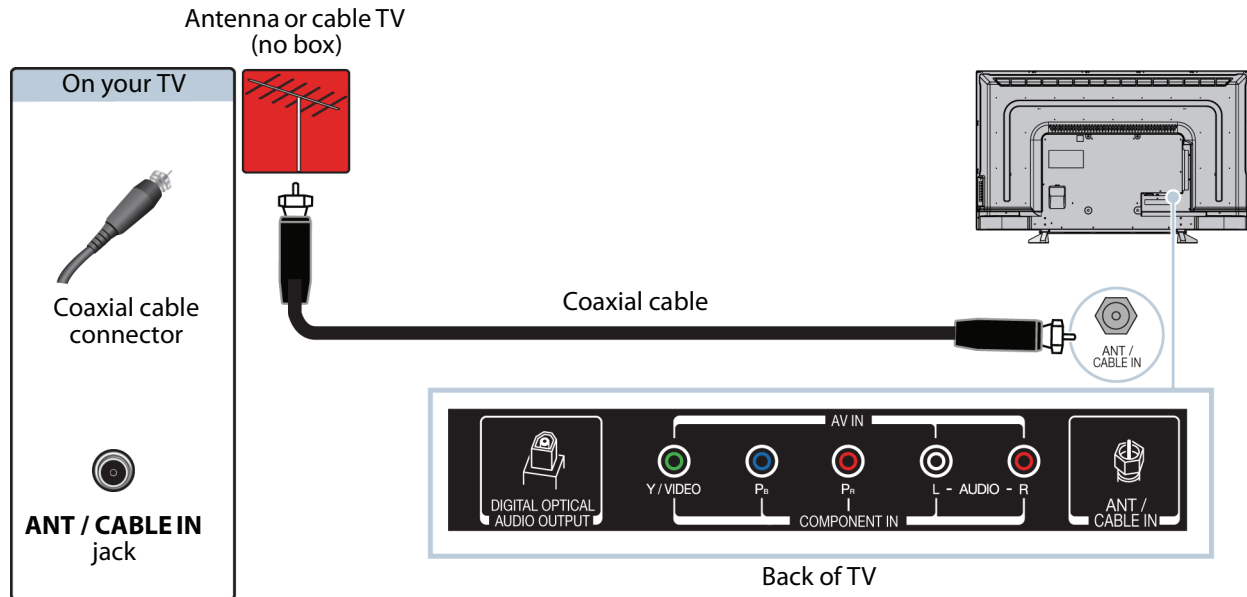

- 1 Make sure that your TV's power cord is unplugged and all connected equipment is turned off.
- 2 Connect a coaxial cable (not provided) to the **ANT / CABLE IN** jack on the back of your TV and to the antenna or cable TV wall jack.
- 3 Plug your TV's power cord into a power outlet, then turn on your TV.
- 4 Press **INPUT** to open the *Input Selection* list.
- 5 Press **▲** or **▼** to highlight **ANT / CABLE**, then press **ENTER**.
- 6 If you cannot tune to channels you know exist, scan for channels. See [Automatically scanning for channels](#) on page 59.

Notes

- Use a coaxial cable to eliminate interference and noise from radio waves.
- Do not bundle the coaxial cable with the power cord or other cables.
- If the antenna is not installed correctly, contact qualified service personnel to correct the problem.
- If the signal level for a channel is weak, the picture may be distorted. Adjust the antenna or use a highly directional outdoor or set-top antenna with a built-in amplifier.
- If the picture quality is good on some channels and poor on others, the problem may be caused by a poor or weak signal from the broadcaster or cable TV provider.
- If you connect to cable TV without a set-top box and experience poor picture quality, you may need to install a set-top box to improve signal reception and picture quality. Contact your cable TV provider about upgrading to a set-top box.
- Many high-definition (HD) channels upscale standard-definition (SD) content. The picture displayed on your TV is still displayed as SD, thus the picture quality will not be as clear or crisp as it would be if the content was originally recorded in HD.

Connecting a DVD or Blu-ray player

Many DVD or Blu-ray players have more than one connection type. To get the best video, you should use the best connection type available. For more information, see [What connection should I use?](#) on page 17.

You can connect a DVD or Blu-ray player using:

- HDMI (best)
- Component video (better)
- AV (composite video) (good)

HDMI (best)

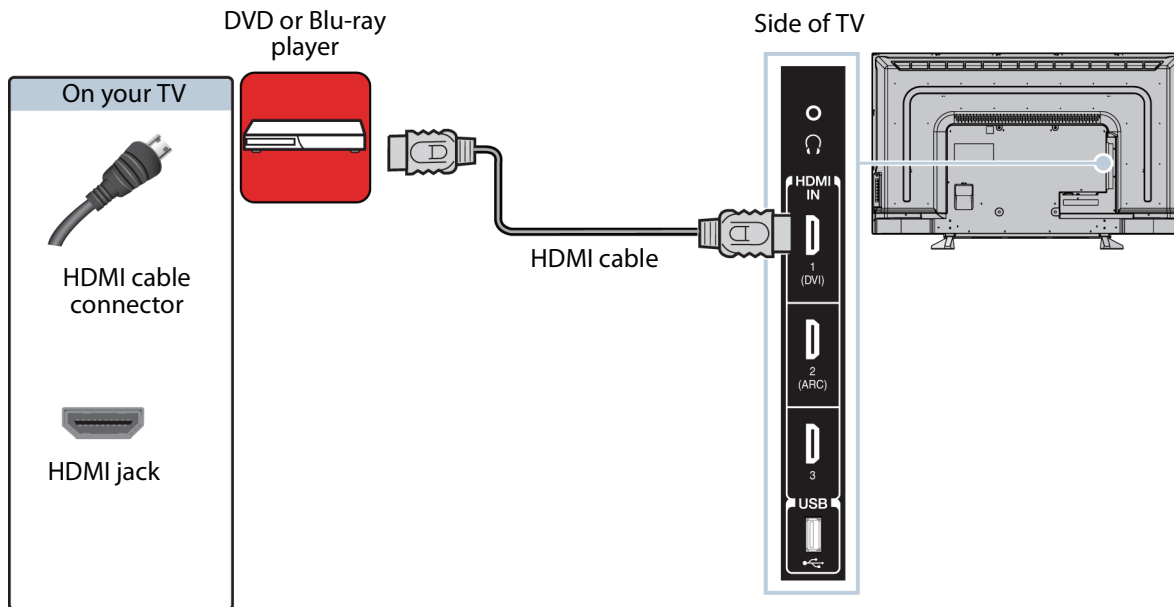

- 1 Make sure that your TV's power cord is unplugged and the DVD or Blu-ray player is turned off.
- 2 Connect an HDMI cable (not provided) to one of the **HDMI** jacks on the side of your TV and to the **HDMI OUT** jack on the DVD or Blu-ray player.
- 3 Plug your TV's power cord into a power outlet, then turn on your TV and DVD or Blu-ray player.
- 4 Press **INPUT** to open the *Input Selection* list.
- 5 Press **▲** or **▼** to highlight **HDMI 1**, **HDMI 2**, or **HDMI 3**, then press **ENTER**.

Note

An HDMI cable carries both audio and video. You do not need to use any audio cables.

Component video (better)

Note

Cables are often color-coded to match color-coded jacks.

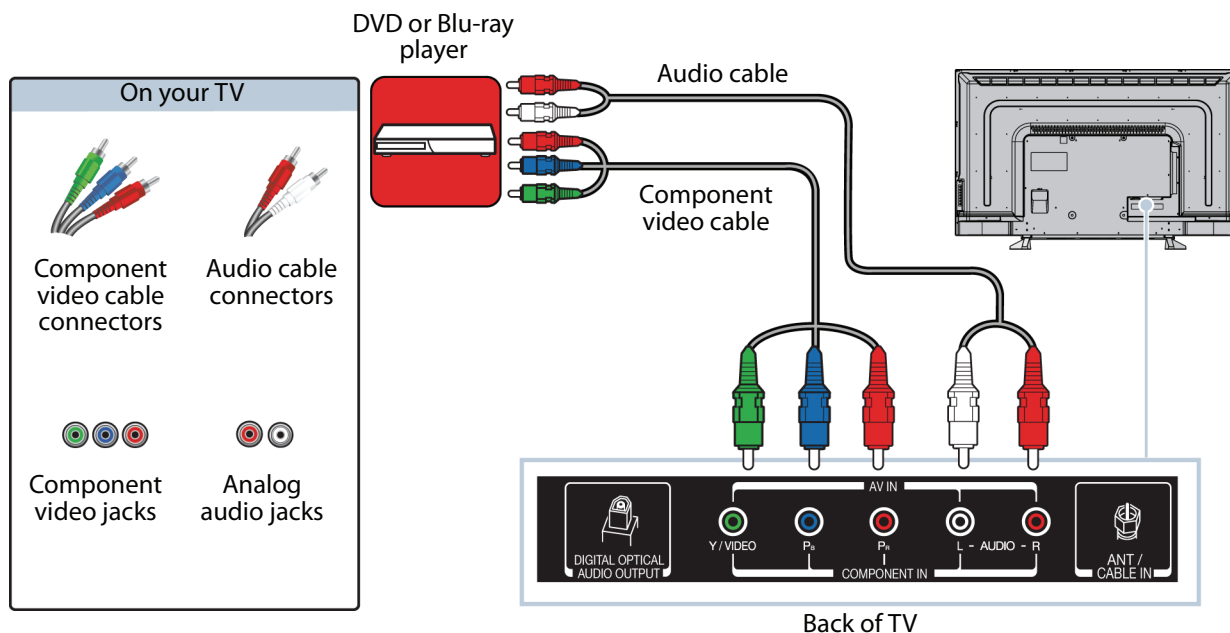

- 1 Make sure that your TV's power cord is unplugged and the DVD or Blu-ray player is turned off.
- 2 Connect a component video cable (not provided) to the **Y/VIDEO**, **P_B**, and **P_R** jacks on the back of your TV and to the **COMPONENT OUT** jacks on the DVD or Blu-ray player.
- 3 Connect an audio cable (not provided) to the **AUDIO L** and **R** jacks on the back of your TV and to the **L** and **R AUDIO OUT** jacks on the DVD or Blu-ray player.

Important

- The **Y/VIDEO**, **P_B**, and **P_R** video jacks (used to connect a component device) share the **AUDIO L** and **R** jacks with the **Y/VIDEO** jack (used to connect an AV device). You can only connect one component video or AV device at a time. We suggest upgrading to HDMI if your DVD or Blu-ray player supports it.
- When you connect the audio using the **AUDIO L** and **R** jacks, the audio output is analog.

- 4 Plug your TV's power cord into a power outlet, then turn on your TV and DVD or Blu-ray player.
- 5 Press **INPUT** to open the *Input Selection* list.
- 6 Press **▲** or **▼** to highlight **COMPONENT**, then press **ENTER**.

AV (composite video) (good)

Notes

- Cables are often color-coded to match color-coded jacks.
- The yellow video connector on the AV cable connects to the green **Y/VIDEO** jack.

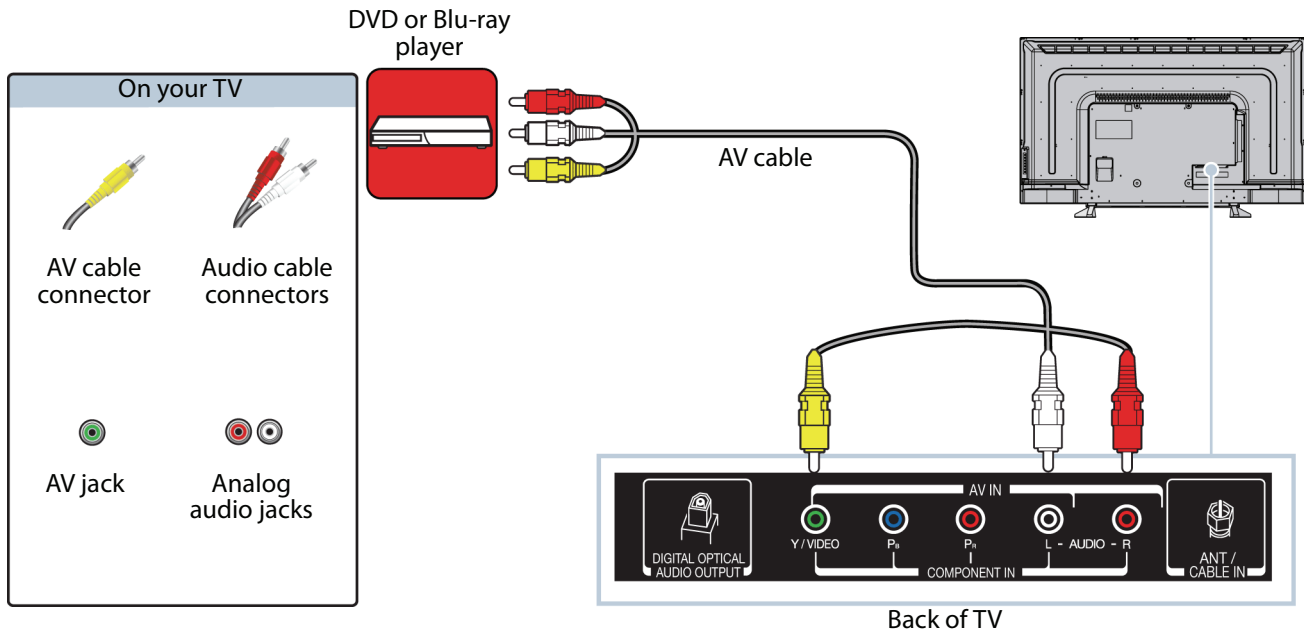

- 1 Make sure that your TV's power cord is unplugged and the DVD or Blu-ray player is turned off.
- 2 Connect an AV cable (not provided) to the green **Y/VIDEO** jack and **AUDIO L** and **R** jacks on the back of your TV and to the **AV OUT** jacks on the DVD or Blu-ray player.

Important

- The **Y/VIDEO**, **P_b**, and **P_r** video jacks (used to connect a component device) share the **AUDIO L** and **R** jacks with the **Y/VIDEO** jack (used to connect an AV device). You can only connect one component video or AV device at a time. We suggest upgrading to HDMI if your DVD or Blu-ray player supports it.
- When you connect the audio using the **AUDIO L** and **R** jacks, the audio output is analog.

- 3 Plug your TV's power cord into a power outlet, then turn on your TV and DVD or Blu-ray player.
- 4 Press **INPUT** to open the *Input Selection* list.
- 5 Press **▲** or **▼** to highlight **AV**, then press **ENTER**.

Connecting a game console

You can connect a game console using:

- HDMI (best)
- Component video (better)
- AV (composite video) (good)

HDMI (best)

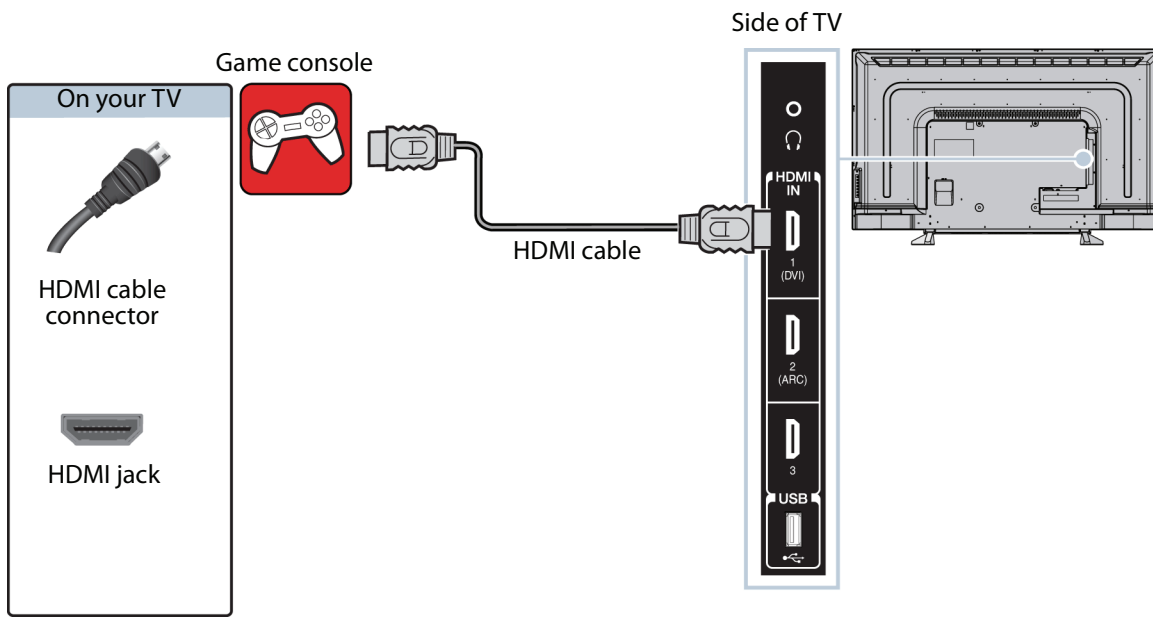

- 1 Make sure that your TV's power cord is unplugged and the game console is turned off.
- 2 Connect an HDMI cable (not provided) to one of the **HDMI** jacks on the side of your TV and to the **HDMI OUT** jack on the game console.
- 3 Plug your TV's power cord into a power outlet, then turn on your TV.
- 4 Turn on the game console, then set it to the correct output mode. For more information, see the documentation that came with the console.
- 5 Press **INPUT** to open the *Input Selection* list.
- 6 Press **▲** or **▼** to highlight **HDMI 1**, **HDMI 2**, or **HDMI 3**, then press **ENTER**.

Note

An HDMI cable carries both audio and video. You do not need to use any audio cables.

Component video (better)

Note
Cables are often color-coded to match color-coded jacks.

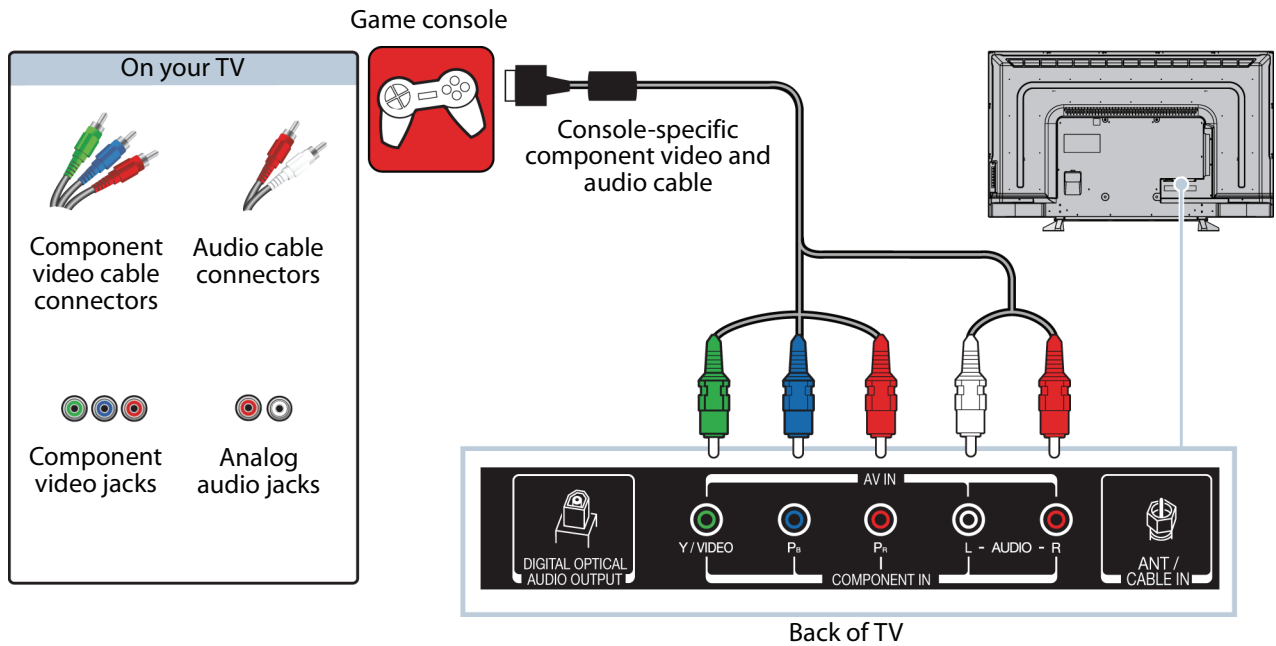

- 1 Make sure that your TV's power cord is unplugged and the game console is turned off.
- 2 Connect the video and audio connectors on the component video cable (not provided) to the **Y/VIDEO**, **P_B**, and **P_R** video jacks and **AUDIO L** and **R** jacks on the back of your TV and to the component jack(s) on the game console.

Important

- Your game console may require a special component video cable. See the documentation that came with your game console or check the manufacturer's website.
- The **Y/VIDEO**, **P_B**, and **P_R** video jacks (used to connect a component device) share the **AUDIO L** and **R** jacks with the **Y/VIDEO** jack (used to connect an AV device). You can only connect one component video or AV device at a time. We suggest upgrading to HDMI if your game console supports it.
- When you connect the audio using the **AUDIO L** and **R** jacks, the audio output is analog.

- 3 Plug your TV's power cord into a power outlet, then turn on your TV.
- 4 Turn on the game console, then set it to the correct output mode. For more information, see the documentation that came with the console.
- 5 Press **INPUT** to open the *Input Selection* list.
- 6 Press **▲** or **▼** to highlight **COMPONENT**, then press **ENTER**.

AV (composite video) (good)**Notes**

- Cables are often color-coded to match color-coded jacks.
- The yellow video connector on the AV cable connects to the green **Y/VIDEO** jack.

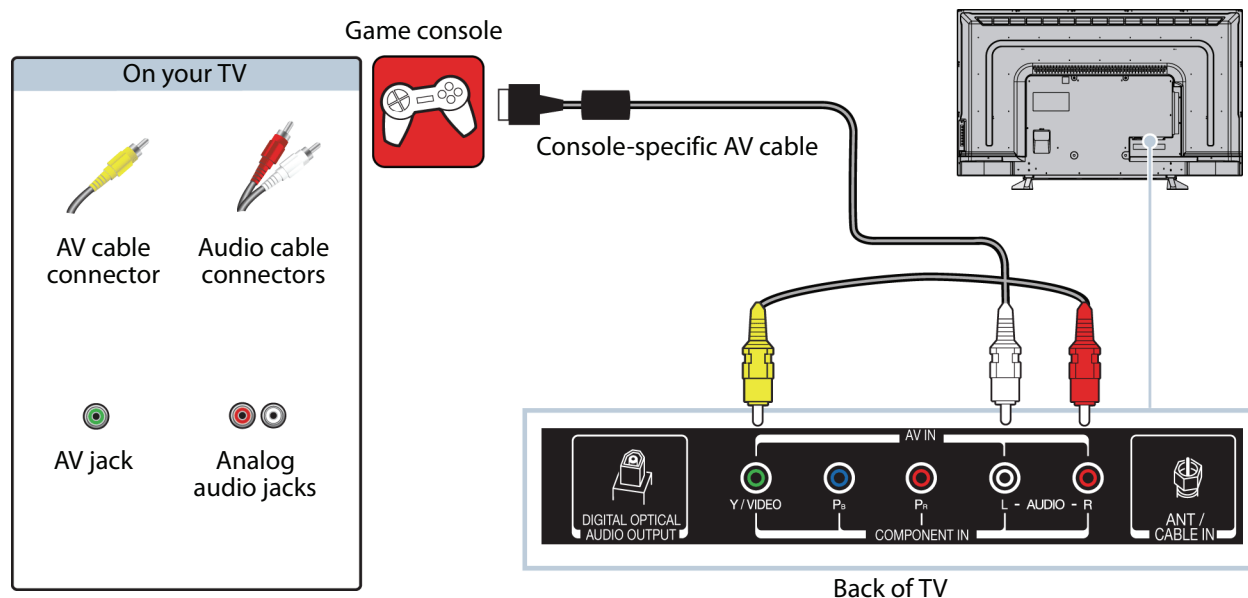

- 1 Make sure that your TV's power cord is unplugged and the game console is turned off.
- 2 Connect the video and audio connectors on the game console's AV cable (not provided) to the green **Y/VIDEO** jack and **AUDIO L** and **R** jacks on the back of your TV and to the composite jack(s) on the game console.

Important

- Most game consoles come with a special AV cable. See the documentation that came with your game console or check the manufacturer's Web site.
- The **Y/VIDEO**, **P_b**, and **P_r** video jacks (used to connect a component device) share the **AUDIO L** and **R** jacks with the **Y/VIDEO** jack (used to connect an AV device). You can only connect one component video or AV device at a time. We suggest upgrading to HDMI if your game console supports it.
- When you connect the audio using the **AUDIO L** and **R** jacks, the audio output is analog.

- 3 Plug your TV's power cord into a power outlet, then turn on your TV.
- 4 Turn on the game console, then set it to the correct output mode. For more information, see the documentation that came with the console.
- 5 Press **INPUT** to open the *Input Selection* list.
- 6 Press **▲** or **▼** to highlight **AV**, then press **ENTER**.

Connecting a computer

You can connect a computer using:

- HDMI (best)
- DVI (same as HDMI but requires an audio connection)

HDMI (best)

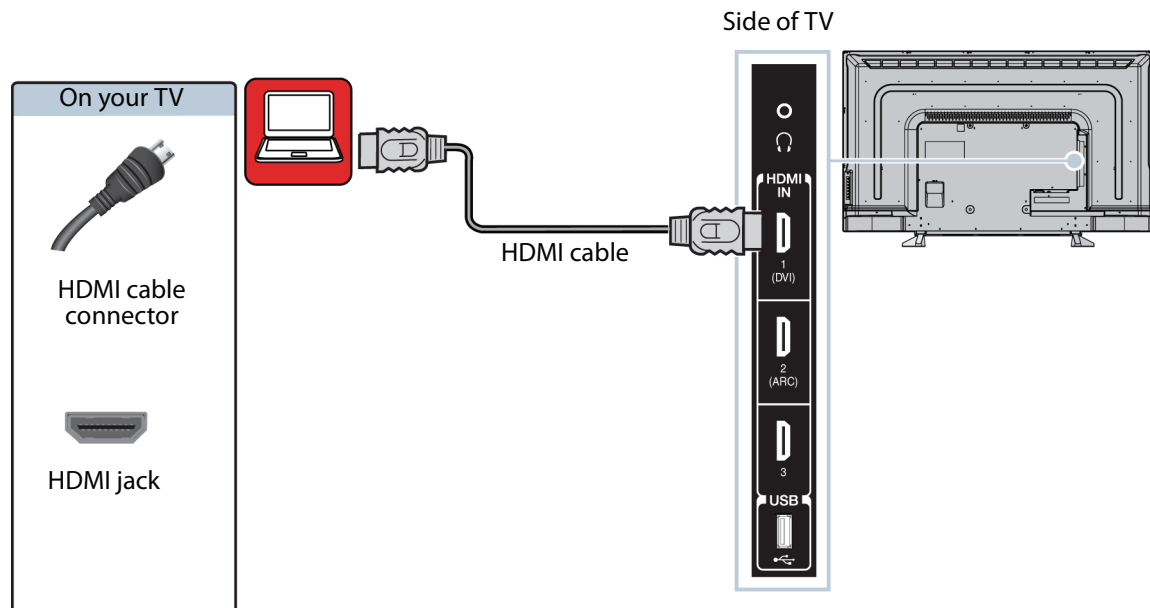

- 1 Make sure that your TV's power cord is unplugged and the computer is turned off.
- 2 Connect an HDMI cable (not provided) to one of the **HDMI** jacks on the side of your TV and to the **HDMI OUT** jack on the computer.
- 3 Plug your TV's power cord into a power outlet, then turn on your TV and the computer.
- 4 Press **INPUT** to open the *Input Selection* list.
- 5 Press **▲** or **▼** to highlight **HDMI 1**, **HDMI 2**, or **HDMI 3**, then press **ENTER**.
- 6 Adjust the display properties on the computer, if necessary.

DVI (same as HDMI but requires an audio connection)**Notes**

- You must use the **HDMI IN 1 (DVI)** jack to connect a computer using DVI.
- Your TV supports DVI video only. To add sound for a DVI connection, connect external speakers or a sound bar to the computer.

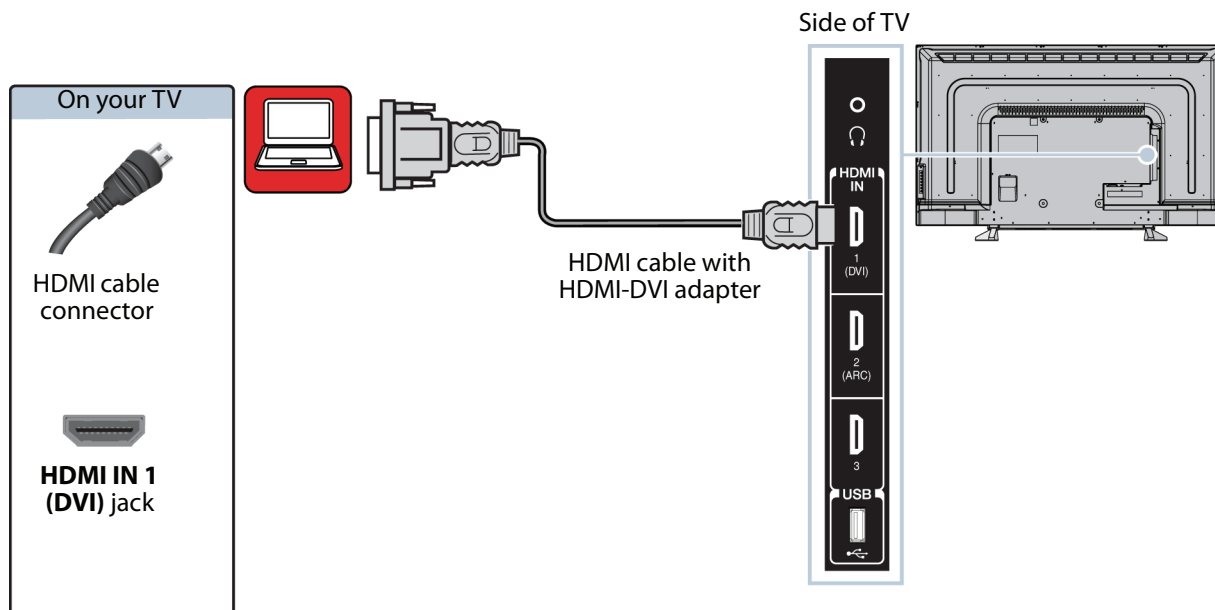

- 1 Make sure that your TV's power cord is unplugged and the computer is turned off.
- 2 Connect an HDMI-DVI adapter (not provided) to one end of an HDMI cable (not provided), then connect the adapter to the **DVI OUT** jack on the computer.
- 3 Connect the other end of the cable to the **HDMI 1 (DVI)** jack on the side of your TV.
- 4 Plug your TV's power cord into a power outlet, then turn on your TV and the computer.
- 5 Press **INPUT** to open the *Input Selection* list.
- 6 Press **▲** or **▼** to select **HDMI 1**, then press **ENTER**.
- 7 Adjust the display properties on the computer, if necessary.

Connecting a USB flash drive

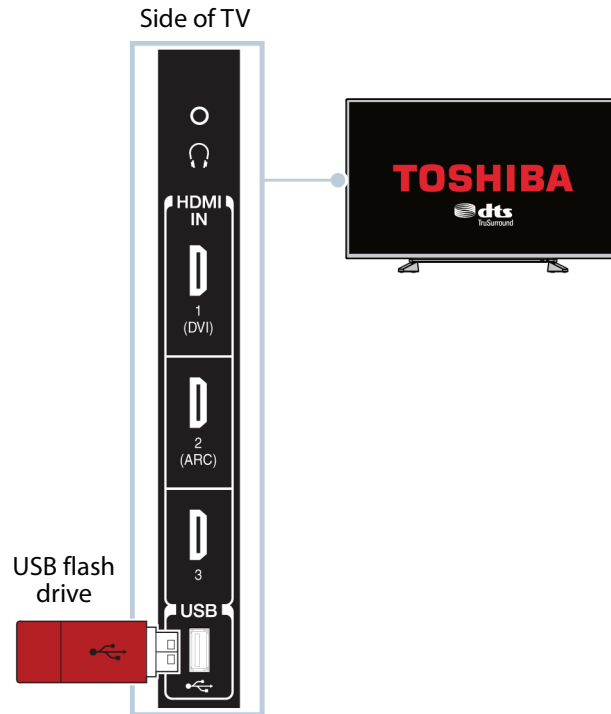

- 1 Plug a USB flash drive into the **USB** port on the side of your TV.

Caution

Do not remove the USB flash drive or turn off the TV while using the USB flash drive. You may lose data or damage the USB flash drive.

- 2 If your TV is turned on and **Auto Start** is set to **On**, press ◀ or ▶ to select **Yes** in the message that appears, then press **ENTER**. The *Media Player* menu opens.

OR

If **Auto Start** is set to **Off**, press **INPUT**, press ▲ or ▼ to highlight **USB**, then press **ENTER**. Press ▲ or ▼ to highlight **Photo**, then press **ENTER**. The *Media Player* menu opens.

For more information, see [Turning Auto Start on or off](#) on page 49.

Note

For information about supported file types, see [Supported photo file formats](#) on page 49.

Connecting headphones

If the **TV Speakers** option on the *Sound* menu is set to **Auto**, the TV speakers are muted when you connect headphones.

Warning

Loud noise can damage your hearing. When using headphones, use the lowest volume setting on your headphones that still lets you hear the sound.

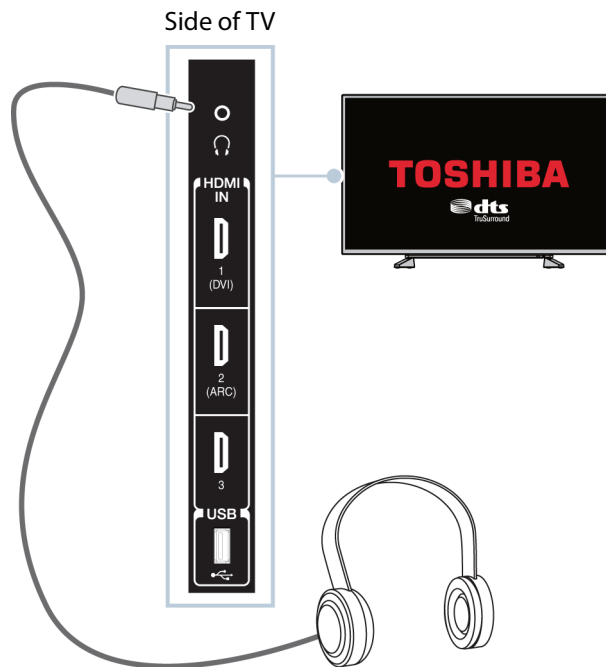

- 1 Make sure that your TV is turned on, then connect the headphones to the  jack on the side of your TV.
- 2 In the screen that opens, press **◀** or **▶** to highlight **Headphones/Audio Output**, then press **ENTER**.

Connecting external speakers or a sound bar

You can connect external speakers using:

- Digital audio
- Analog audio

Digital audio

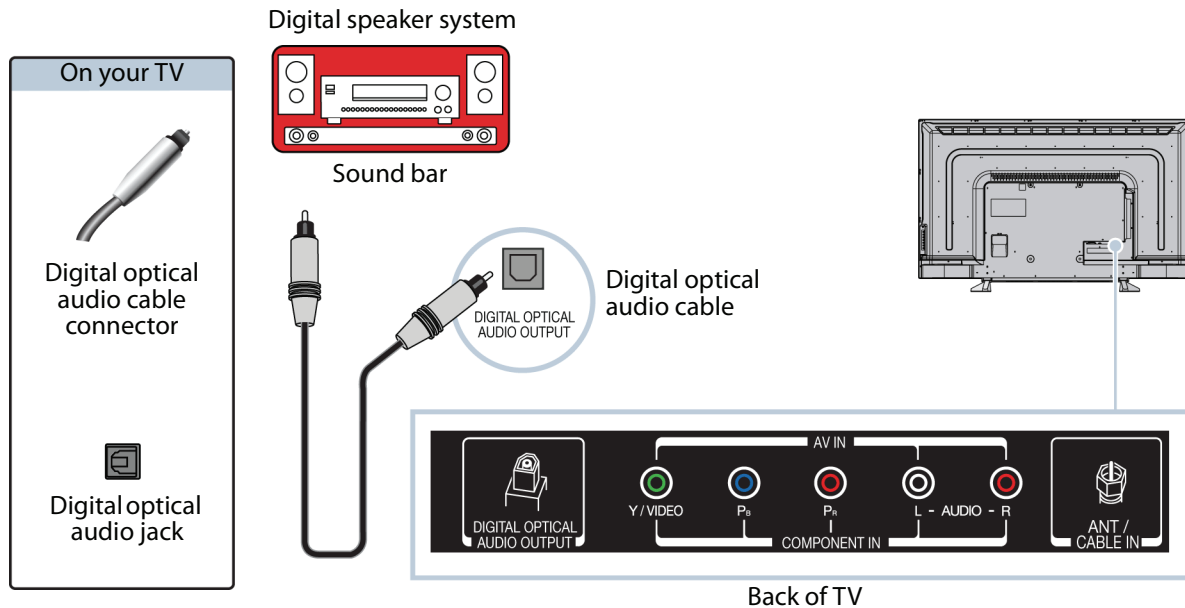



- 1 Make sure that your TV's power cord is unplugged and the digital speaker system or sound bar is turned off.
- 2 Connect a digital optical audio cable (not provided) to the **DIGITAL OPTICAL AUDIO OUTPUT** jack on the back of your TV and to the optical **AUDIO IN** jack on the digital speaker system or sound bar.
- 3 Plug your TV's power cord into a power outlet, then turn on your TV.
- 4 Turn on the digital speaker system or sound bar, then set it to the correct source. For more information, see the documentation that came with the digital speaker system or sound bar.
- 5 On your TV's *Sound* menu, highlight **Digital Audio Output**, then press **ENTER**. Highlight **Audio Format**, then press **ENTER**. Press **▲** or **▼** to select **PCM**, then press **ENTER**. See the **Digital Audio Output** option in [Adjusting sound settings](#) on page 55.

Analog audio

Note

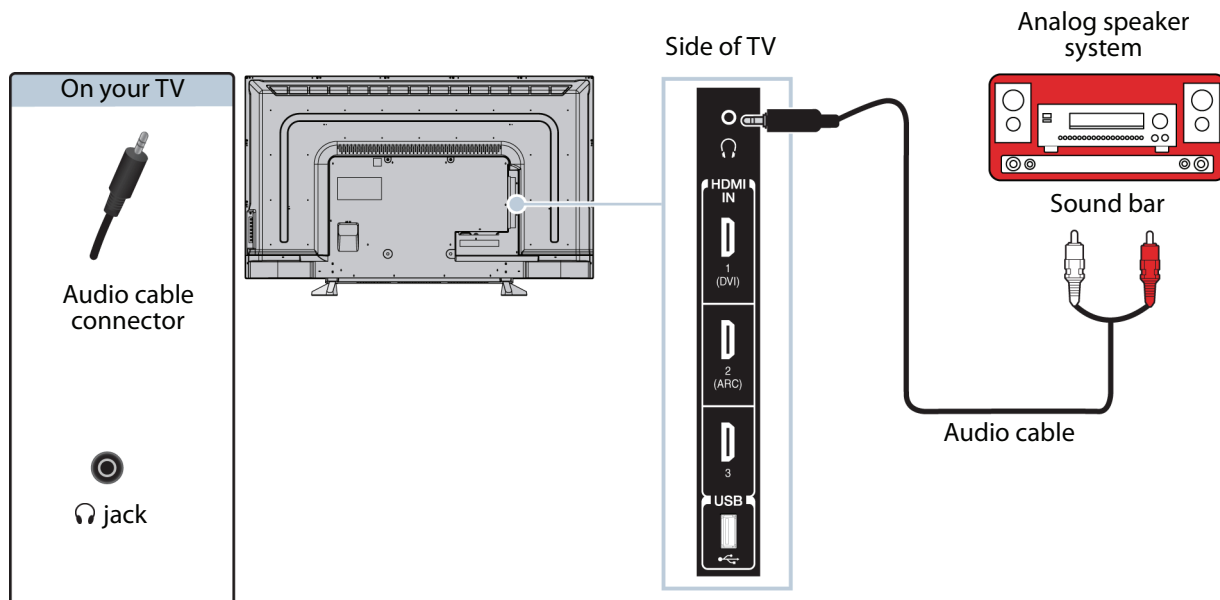
If the **TV Speakers** option on the *Sound* menu is set to **Auto** or **Off**, the TV speakers are muted when you connect an analog sound system or sound bar.



- 1 Make sure that your TV is turned on and the analog speaker system or sound bar is turned off.
- 2 Connect an audio cable (not provided) to the  jack on the side of your TV and to the **AUDIO IN** jacks on the analog speaker system or sound bar.
- 3 In the screen that opens, press ◀ or ▶ to highlight **Audio Output Fixed**, then press **ENTER**.

Note

If you want to mute the TV speakers, set the **TV Speakers** option on the *Sound* menu to **Off** or **Auto**.

- 4 Turn on the analog speaker system or sound bar, then set it to the correct source. For more information, see the documentation that came with the analog speaker system or sound bar.

Connecting a home theater system with multiple devices

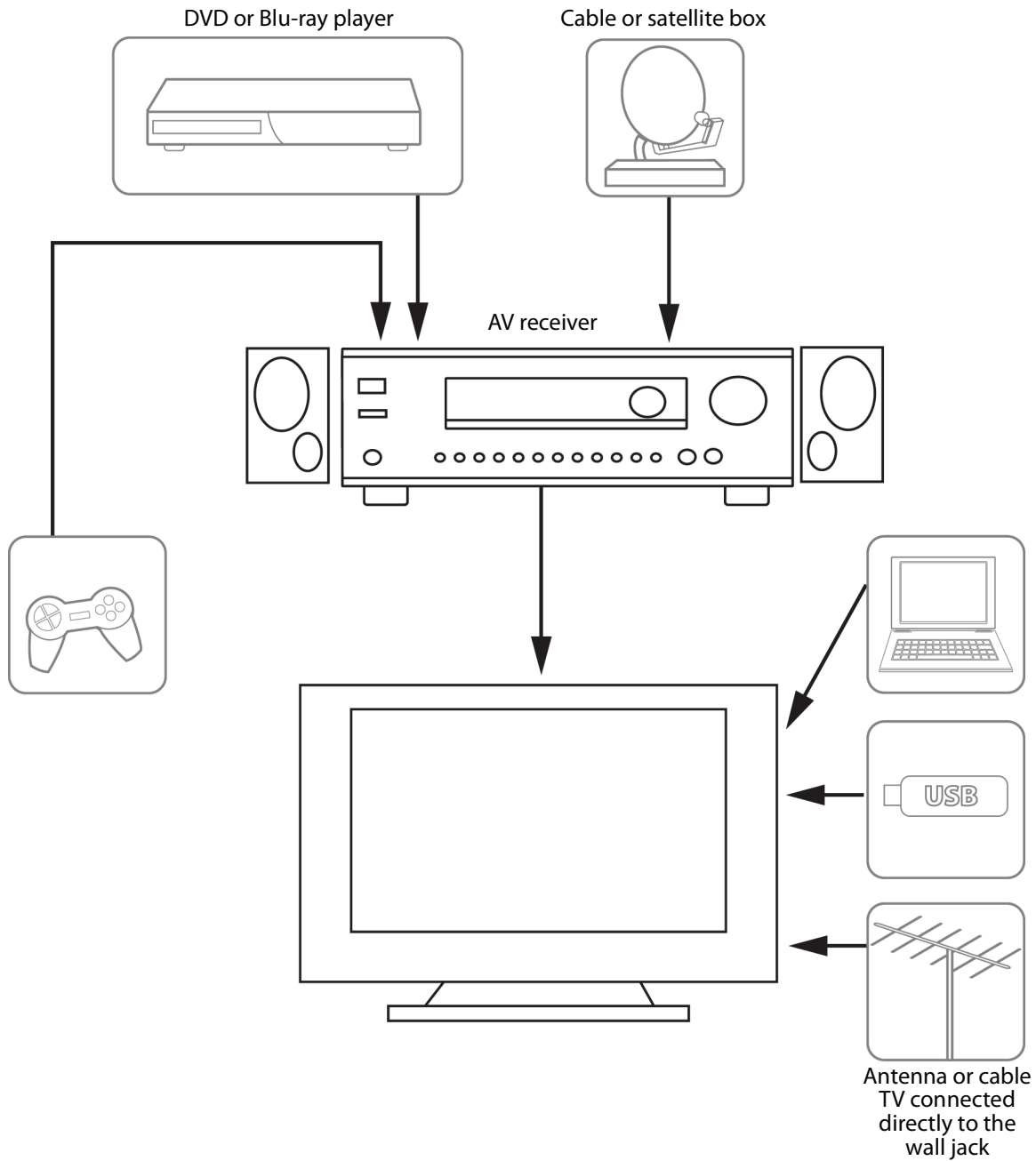

The connections you make depend on the video and audio jacks available on your devices. Refer to the documentation that came with your devices for connection information.

Just remember to use the best connection types available for the best picture and sound. For information about connection types, see [What connection should I use?](#) on page 17.

Connecting power

43-inch

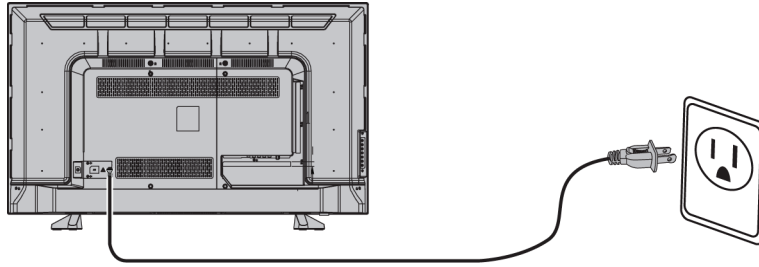

49-inch and 55-inch

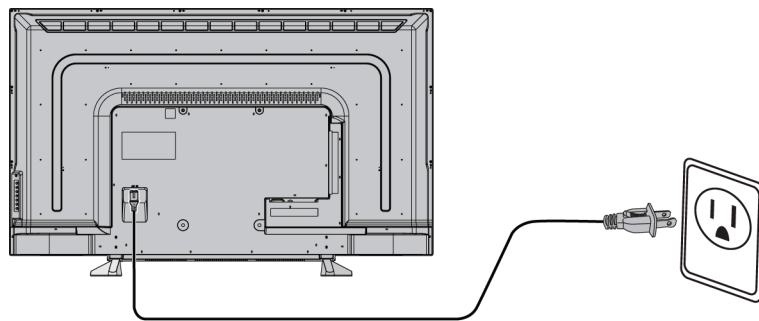

- 1 Connect one end of the power cord to the power connector on the back of your TV.
- 2 Connect the other end of the cord to a power outlet.

Caution

- Your TV should only be operated from the power source indicated on the label.
- Always unplug the power cord from the power outlet when you will not be using your TV for an extended period of time.

Using the remote control

This section includes topics about:

- Installing remote control batteries
- Aiming the remote control
- Programming the CH RTN button

Installing remote control batteries

- 1 While squeezing the release latch on the back of the remote control, lift the battery compartment cover off the remote control.

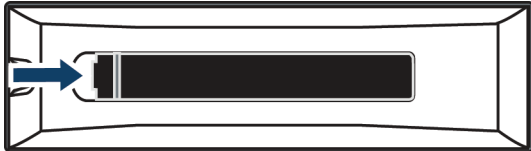

- 2 Insert two AAA batteries into the battery compartment. Make sure that you match the + and - symbols on the batteries with the + and - symbols in the battery compartment.

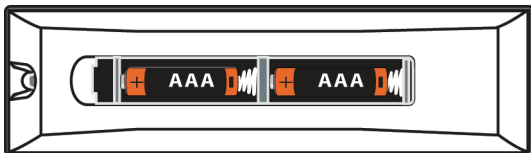

- 3 Replace the battery compartment cover.

Cautions

- Batteries should not be exposed to excessive heat, such as sunshine, heat registers, or fire.
- Battery chemicals can cause a rash. If the batteries leak, clean the battery compartment with a cloth. If chemicals touch your skin, wash immediately.
- Make sure that batteries are disposed of correctly. Do not burn or incinerate.

Notes

- Do not mix batteries of different types.
- Do not mix old and new batteries.
- Remove batteries when the charge is depleted.
- If the remote control is not going to be used for an extended period of time, remove the batteries.

Aiming the remote control

- Point the remote control towards the remote control sensor on the front of your TV.

43-inch model



Remote control sensor

49-inch and 55-inch

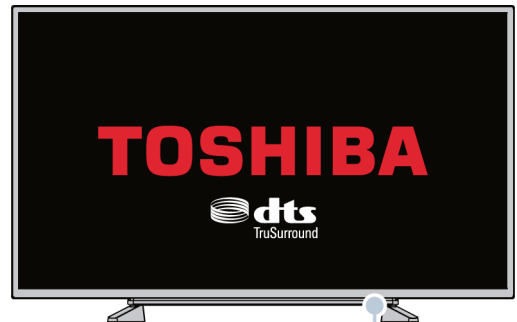

Remote control sensor

Programming the CH RTN button

You can use the SurfLock™ feature to temporarily program a specific channel or video input to the **CH RTN** button so you can return to the programmed channel or input from any other channel or input.

Note

Your TV returns to the programmed channel or input one time only. After you press **CH RTN**, the programmed channel or input is cleared and the **CH RTN** returns to its normal function.

- 1 Tune the TV to the channel or video input you want to program to the **CH RTN** button.
- 2 Press and hold **CH RTN** until *Memorized* appears on the screen. The channel or input has been programmed to the **CH RTN** button. When you press **CH RTN**, your TV tunes to the programmed channel or input.

Turning on your TV for the first time

The first time you turn on your TV, the *Initial Setup* wizard opens. The wizard guides you through setting up basic settings including the menu language, time zone, picture mode, TV signal source, and the channel list.

Note

You must select a language and **Home** or **Store** mode. You cannot exit the *Initial Setup* wizard until you make these selections.

- 1 Make sure that you have:
 - Installed the remote control batteries. (See page 38.)
 - Connected an antenna, cable TV, or satellite TV. (See page 18 through 23.)
 - Connected the power cord. (See page 37.)
- 2 Press **I/O** (power) to turn on your TV. The *Initial Setup* wizard opens.

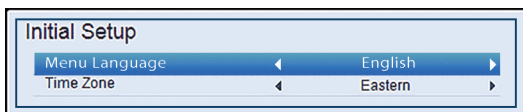

- 3 Press **◀** or **▶** to highlight a language.
- 4 Press **▲** or **▼** to highlight **Time Zone**, press **◀** or **▶** to select your time zone, then press **ENTER**.

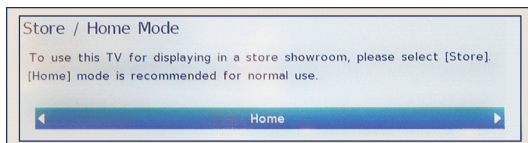

- 5 Press **◀** or **▶** to highlight **Home** or **Store** mode, then press **ENTER**.

For normal home use, you should select **Home** mode. If you select **Store** mode, every time you turn on your TV, it will be in Store mode. **Store** mode is not an energy savings mode.

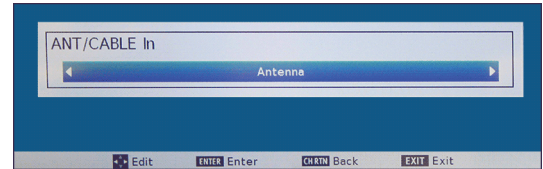

- 6 Press **◀** or **▶** to highlight **Antenna** or **Cable**, then press **ENTER**.

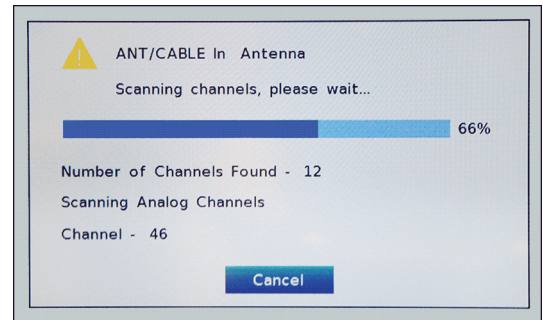

- 7 If you are using an antenna or connecting a cable box directly to a wall jack, press **ENTER** again. Your TV starts scanning for channels available in your viewing area.

OR

If you connected a cable box or a satellite box, press **EXIT** to close the wizard. You do not need to scan for channels.

After the wizard closes, the *Auto Tuning (Antenna)* menu opens with the first found channel highlighted.

- 8 Press **EXIT** to close the menu.

Setting up the video input jacks

This section includes topics about:

- Setting up the ANT / CABLE IN jack
- Setting the RGB range for HDMI jacks

Setting up the ANT / CABLE IN jack

If you connect an antenna or cable TV without a box to the **ANT / CABLE IN** jack, you need to set up the jack so your TV correctly displays channels.

- 1 Press **MENU**, press **▲** or **▼** to highlight **Installation**, then press **ENTER**.

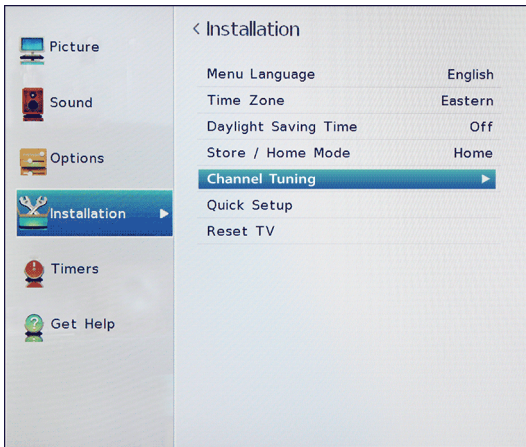

- 2 Highlight **Channel Tuning**, then press **ENTER**.

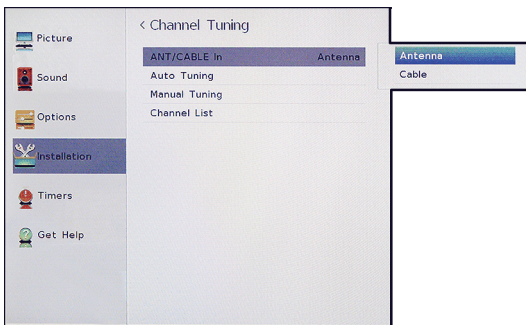

- 3 Highlight **ANT/CABLE In**, then press **ENTER**.
- 4 Highlight your TV input source, then press **ENTER**. Select:
 - **Antenna** if you connected an antenna to the **ANT / CABLE IN** jack
 - **Cable** if you connected cable TV without a box to the **ANT / CABLE IN** jack
- 5 Press **EXIT** to close the menu.

Setting the RGB range for HDMI jacks

You can select the RGB range for the HDMI jacks.

Note
If your HDMI device does not support the HDMI RGB Range feature, your TV may not work correctly when you turn on this feature.

- 1 Press **MENU**, press **▲** or **▼** to highlight **Options**, then press **ENTER**.

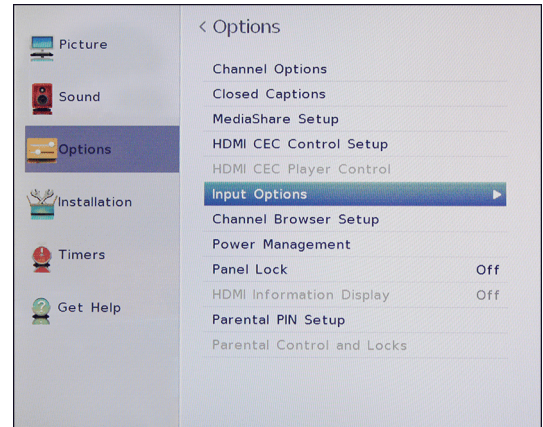

- 2 Highlight **Input Options**, then press **ENTER**.

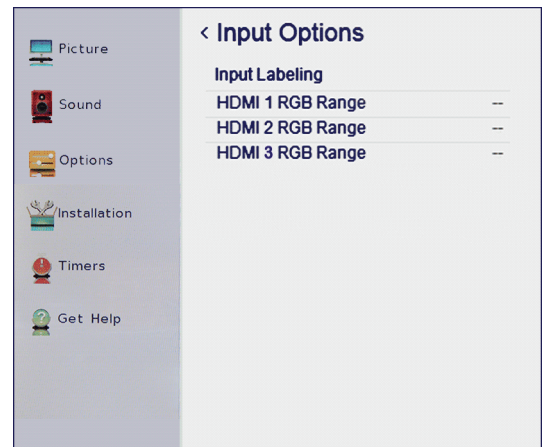

- 3 Highlight **HDMI 1 RGB Range**, **HDMI 2 RGB Range**, or **HDMI 3 RGB Range**, then press **ENTER**.
- 4 Highlight an option, then press **ENTER**. Select:
 - **Auto**—(Default) Adjusts the RGB full range signal automatically.
 - **Full**—The RGB input signal is displayed in the range of 0 to 255.
 - **Limited**—The RGB input signal is displayed in the range from 16 to 235.
- 5 Press **EXIT** to close the menu.

Understanding the basics

This section covers basic information for:

- Turning your TV on or off
- Selecting the video input source
- On-screen menu overview
- Navigating the menus
- Adjusting the volume
- Selecting a channel
- Viewing channel information
- Viewing HDMI information

Turning your TV on or off

- 1 Make sure that the power cord is connected securely and correctly. For more information, see [Connecting power](#) on page 37.
- 2 Press **I/⏻** (power) to turn on your TV. The power indicator turns off.
- 3 Press **I/⏻** (power) again to turn off your TV. Your TV enters standby mode, and the power indicator turns red.

Warning

When your TV is in standby mode, it is still receiving power. To completely disconnect power, unplug the power cord.

Note

If your TV does not receive an input signal for 15 minutes, it automatically goes into standby mode.

Last Mode Memory

If power is interrupted while you are viewing TV, the Last Mode Memory feature automatically turns on your TV when the power is restored.

Selecting the video input source

- 1 Press **INPUT**. The *Input Selection* list opens.

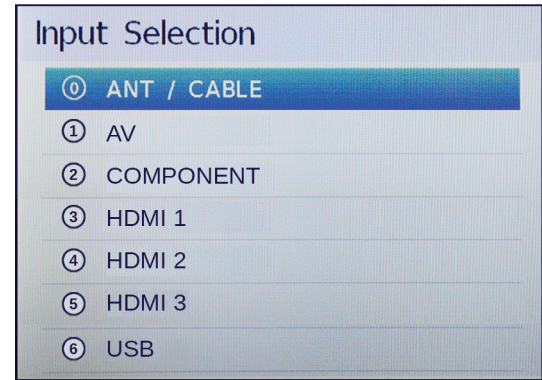

- 2 Do one of the following:
 - Press **INPUT** one or more times until the video input you want is selected.
 - Press **▲** or **▼** to highlight the video input you want, then press **ENTER**.
 - Press the number for the video input you want. You can select:
 - **0** for a device connected to the **ANT / CABLE IN** jack
 - **1** for an AV device connected to the **Y/VIDEO** jack
 - **2** for a component video device connected to the **Y/VIDEO**, **PB**, and **PR** jacks
 - **3** for a device connected to the **HDMI IN 1 (DVI)** jack
 - **4** for a device connected to the **HDMI IN 2 (ARC)** jack
 - **5** for a device connected to the **HDMI IN 3** jack
 - **6** for a USB flash drive connected to the **USB** jack.
- 3 Press **EXIT** to close the menu.

Notes

- If a CEC-compatible device is connected to an HDMI jack, the HDMI® CEC icon appears in the list.
- If a connected CEC-compatible device has CEC-compatible devices connected to it, a separate device selection pop-up window appears. For example, the popup window for a CEC-compatible DVD player with a CEC-compatible audio receiver connected might appear as follows:



- If you press **INPUT** to select a CEC-compatible device from the popup window, the device may turn on.

On-screen menu overview

Notes

- Depending on the signal source selected, you may see different options on your screen.
- Menu items that are not selectable are grayed out.

Picture menu

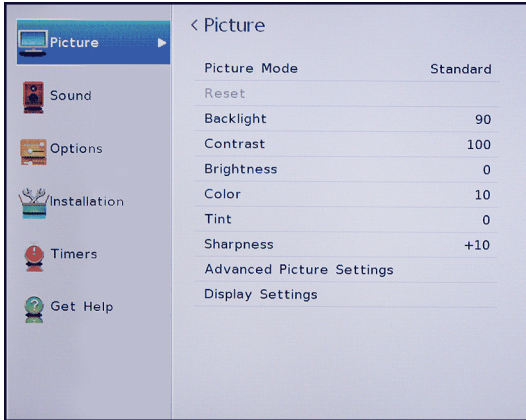

Sound menu

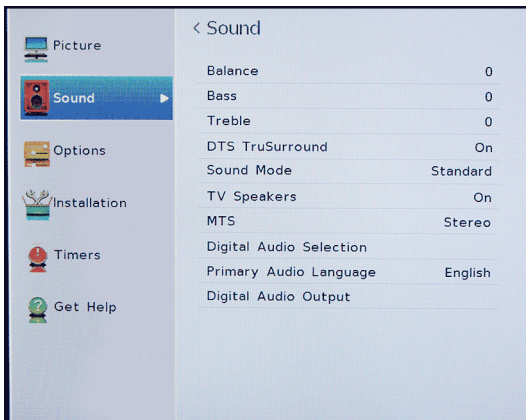

Options menu

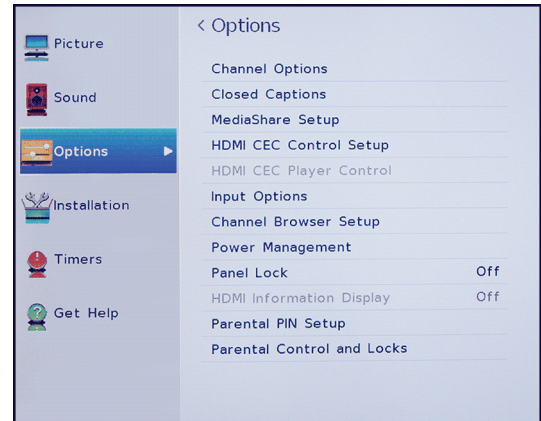

Installation menu



Timers menu

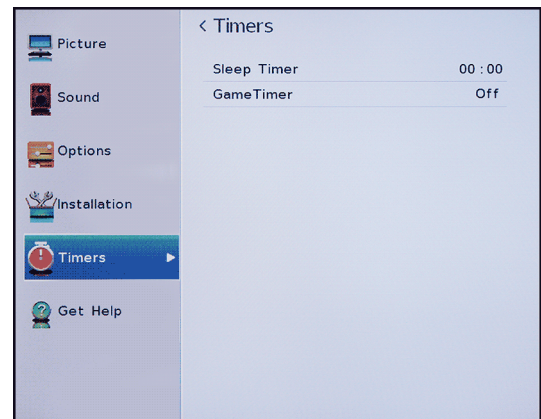

Get Help menu

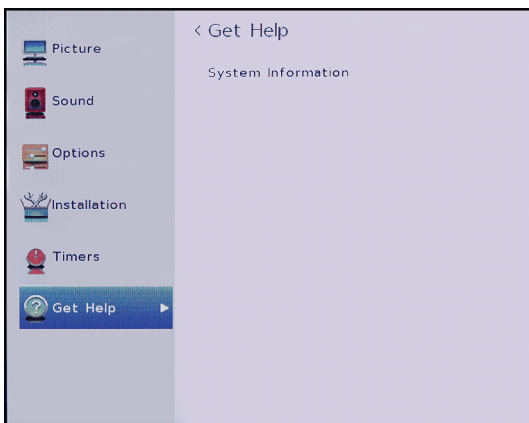

Navigating the menus

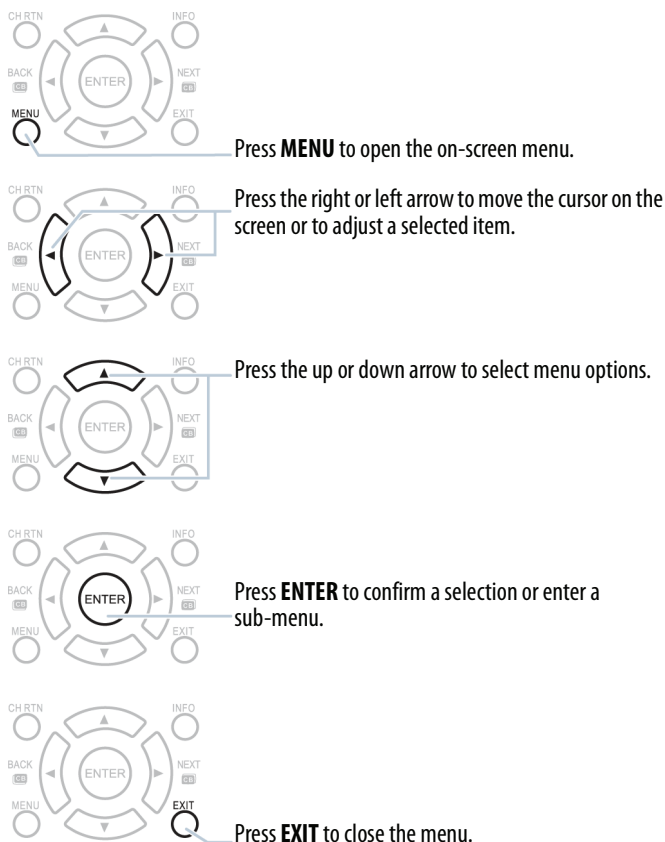

Adjusting the volume

- Press **VOL+** or **VOL-** to increase or decrease the volume.
- Press **MUTE** to mute the sound. Press **MUTE** again to turn the sound back on.

Note
If you adjust a setting on the *Sound* menu while the mute is active, the mute feature is cancelled.

Selecting a channel

- Select a channel from the Channel Browser. See [Using the Channel Browser](#) on page 57.
- Press **CH▲** or **CH▼** to go to the next or previous channel on the memorized channel list.
- Press the number buttons to enter the channel number you want, then wait for the channel to change or press **ENTER** to immediately change the channel.
- To select a digital sub-channel, press the number buttons to select the main digital channel, press — (sub-channel), then press the number button for the sub-channel. Wait for the channel to change, or press **ENTER** to immediately change the channel. For example, to tune to channel 5-1, press **5**, — (sub-channel), then **1**.

Note
Button presses must be within two seconds of each other.

- Press **CH RTN** (return) to go to the last viewed channel. You can program a specific channel to the **CH RTN** button so you can return to the programmed channel from any other channel. See [Programming the CH RTN button](#) on page 39.
- Press **FAV** to open the favorite channel list, press ◀ or ▶ to highlight a channel, then press **ENTER**. For information about setting up a favorite channel list, see [Setting up the Favorites list](#) on page 61.

Note
If a list has more than one page, press ◀ or ▶ to scroll through the pages.

Viewing channel information

Press **INFO** or **RECALL**. The following status information is displayed:

- Current video input (for example ANT/CABLE or AV)
- If ANT/CABLE is the current video input, either *CABLE* (for cable TV) or *ANT* (for over-the-air broadcasts)
- If ANT/CABLE is the current video input, channel number
- Digital signal strength indicator
- If the audio mode is analog, Stereo, Mono, or SAP analog audio status
- If the input mode is HDMI®, Dolby® Digital, or PCM
- Video resolution
- Aspect ratio of incoming video signal (4:3 or 16:9)
- TV program or movie rating
- GameTimer (if set)

Pressing **INFO** also displays the following status information for digital channels:

- Title
- Duration
- Detailed program description

Note

If you pressed **INFO**, press **INFO** again to close the banner.

Viewing HDMI information

When **HDMI Information Display** is set to **On** in the *Options* menu and you press **INFO**, the HDMI Information banner opens and displays the following information:

- Resolution
- Scan Type
- Frame Rate
- Aspect
- Bit Depth
- Color Space
- RGB YUV
- Chroma Format

When the **HDMI Information Display** is set to **Off**, the normal banner is displayed.

- 1 Press **MENU**, press **▲** or **▼** to highlight **Options**, then press **ENTER**.

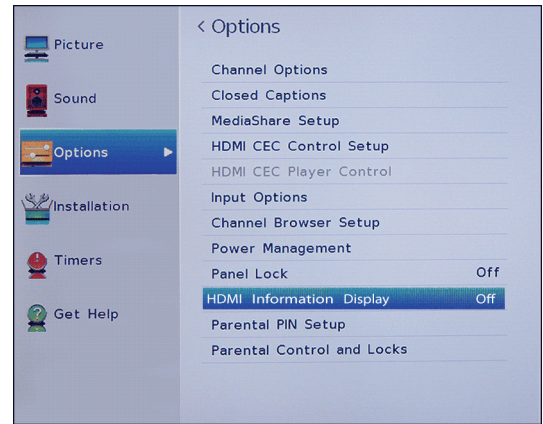

- 2 Highlight **HDMI Information Display**, then press **ENTER**.
- 3 Highlight **On** or **Off**, then press **ENTER**.
- 4 Press **EXIT** to close the menu.

Controlling CEC-compatible devices

This section covers:

- Turning HDMI-CEC Control on or off
- Turning TV Auto Power on or off
- Turning Auto Standby on or off
- Turning Amplifier Control on or off
- Selecting the audio output
- Using the TV remote to control CEC-compatible devices
- Using the TV menu to control CEC-compatible devices

HDMI CEC Control lets you control HDMI CEC-compatible devices connected to the HDMI jacks on your TV using the remote control that came with your TV. To use HDMI CEC Control, you must set the **Enable HDMI CEC Control** setting on the *HDMI CEC Control Setup* menu to **On**.

Notes

- HDMI cables must be used to connect HDMI CEC-compatible devices to your TV.
- The connected device's HDMI CEC feature must be turned on.
- If you connect an HDMI device that is not HDMI CEC-compatible, none of the HDMI CEC Control features work.
- Depending on the connected HDMI device, some HDMI CEC Control features may not work.

Note

When you press **INPUT**, the *Input Selection* list opens. If you select a CEC-compatible video device connected to an HDMI jack and that device is connected to a CEC-compatible audio device, a second selection list opens that shows both devices.

For example, if you connect a CEC-compatible Blu-ray player to an HDMI jack and the Blu-ray player is connected to a CEC-compatible sound bar, the second input selection list might appear as follows:



See [Selecting the video input source](#) on page 41.

Turning HDMI-CEC Control on or off

Note

If **Enable HDMI CEC Control** is set to Off, the other options on the menu are grayed and cannot be used.

- 1 Press **MENU**, press **▲** or **▼** to highlight **Options**, then press **ENTER**.

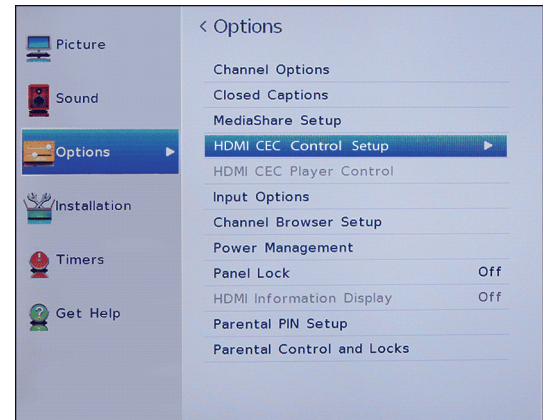

- 2 Highlight **HDMI CEC Control Setup**, then press **ENTER**.

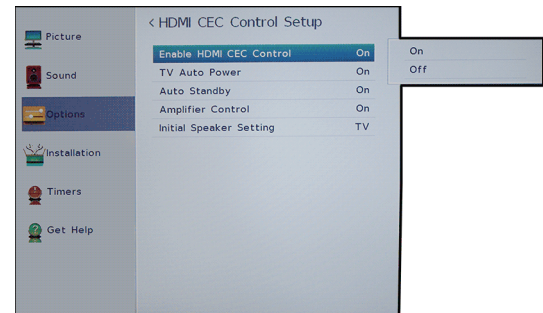

- 3 Highlight **Enable HDMI CEC Control**, then press **ENTER**.
- 4 Highlight **On** or **Off**, then press **ENTER**.
- 5 Press **EXIT** to close the menu.

Turning TV Auto Power on or off

TV Auto Power automatically turns on your TV when an HDMI CEC device is turned on, if the device has this feature.

- 1 Press **MENU**, press **▲** or **▼** to highlight **Options**, then press **ENTER**.

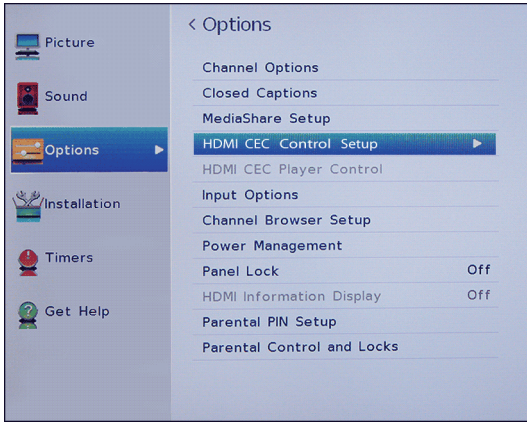

- 2 Highlight **HDMI CEC Control Setup**, then press **ENTER**.

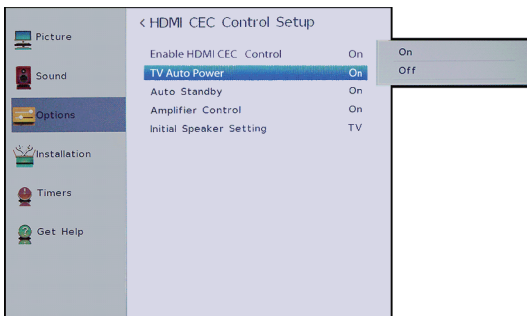

- 3 Make sure that **Enable HDMI CEC Control** is set to **On**.
- 4 Highlight **TV Auto Power**, then press **ENTER**.
- 5 Highlight **On** or **Off**, then press **ENTER**.
- 6 Press **EXIT** to close the menu.

Turning Auto Standby on or off

Auto Standby automatically turns off HDMI CEC devices when you turn off your TV.

- 1 Press **MENU**, press **▲** or **▼** to highlight **Options**, then press **ENTER**.

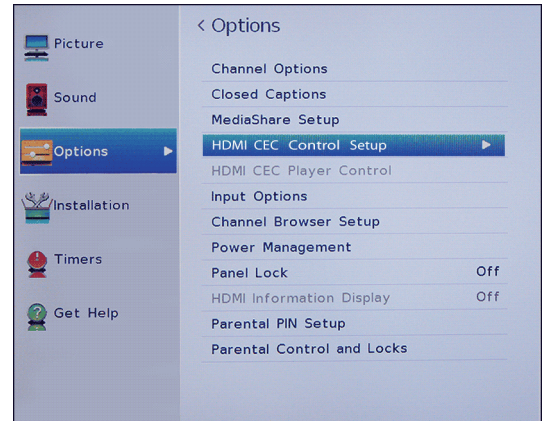

- 2 Highlight **HDMI CEC Control Setup**, then press **ENTER**.

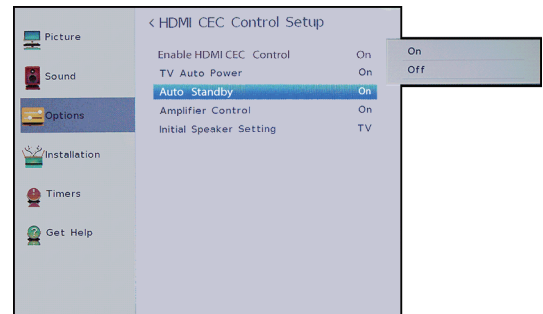

- 3 Make sure that **Enable HDMI CEC Control** is set to **On**.
- 4 Highlight **Auto Standby**, then press **ENTER**.
- 5 Highlight **On** or **Off**, then press **ENTER**.
- 6 Press **EXIT** to close the menu.

Turning Amplifier Control on or off

Amplifier Control lets you use your TV's remote control to control the volume and mute the sound on an audio receiver.

- 1 Press **MENU**, press **▲** or **▼** to highlight **Options**, then press **ENTER**.

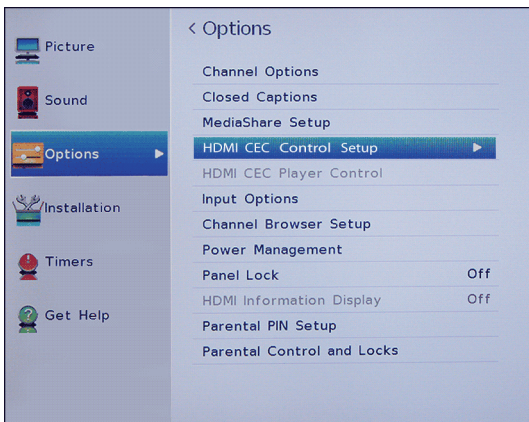

- 2 Highlight **HDMI CEC Control Setup**, then press **ENTER**.

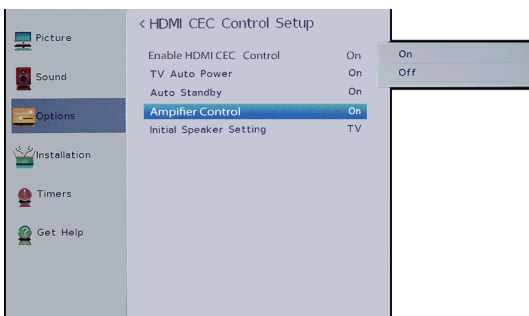

- 3 Make sure that **Enable HDMI CEC Control** is set to **On**.
- 4 Highlight **Amplifier Control**, then press **ENTER**.
- 5 Highlight **On** or **Off**, then press **ENTER**.
- 6 Press **EXIT** to close the menu.

Selecting the audio output

Initial Speaker Setting lets you select whether your TV's remote control controls the TV speakers or a connected audio receiver.

- 1 Press **MENU**, press **▲** or **▼** to highlight **Options**, then press **ENTER**.

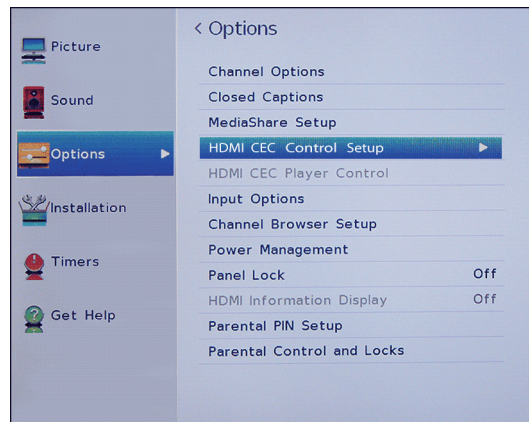

- 2 Highlight **HDMI CEC Control Setup**, then press **ENTER**.

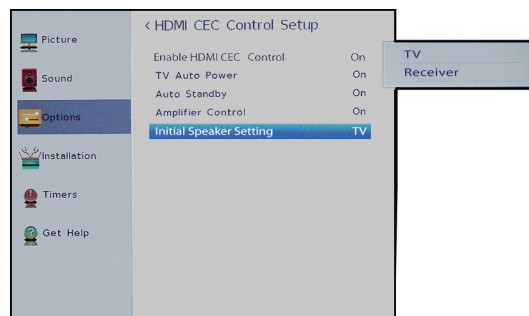

- 3 Make sure that **Enable HDMI CEC Control** is set to **On**.
- 4 Highlight **Initial Speaker Setting**, then press **ENTER**.
- 5 Highlight **TV** or **Receiver**, then press **ENTER**.
- 6 Press **EXIT** to close the menu.

Using the TV remote to control CEC-compatible devices

When **Enable HDMI CEC Control** on the *HDMI CEC Control Setup* menu is set to **On**, you can use the remote control that came with your TV to control a CEC-compatible device (such as a DVD or Blu-ray player).

Button	Press to...
PLAY	Begin playback.
STOP	Stop playback.
PAUSE	Pause the video during play or record mode.
SKIP ►►	Skip forward.
SKIP ◀◀	Skip backward.
FF	Fast-forward.
REW	Rewind or fast-reverse.
▲ ▼ ◀ ▶	Navigate menu options.
ENTER	Enter menu options.
EXIT	Return to the previous menu.

Note
These functions depend on the devices connected.

Using the TV menu to control CEC-compatible devices

When **Enable HDMI CEC Control** on the *HDMI CEC Control Setup* menu is set to **On**, you can use the TV menu to turn on a CEC-compatible device (such as a DVD or Blu-ray player) and access features on the device.

Note
These functions depend on the devices connected.
The HDMI CEC Player Control option is grayed if:

- A non-HDMI input is currently selected.
- The **Enable HDMI CEC Control** option is set to **Off**.
- The connected CEC device is not a playback or recording device.

- 1 Make sure that **Enable HDMI CEC Control** is set to **On**. See [Turning HDMI-CEC Control on or off](#) on page 45.
- 2 Press **MENU**, press ▲ or ▼ to highlight **Options**, then press **ENTER**.

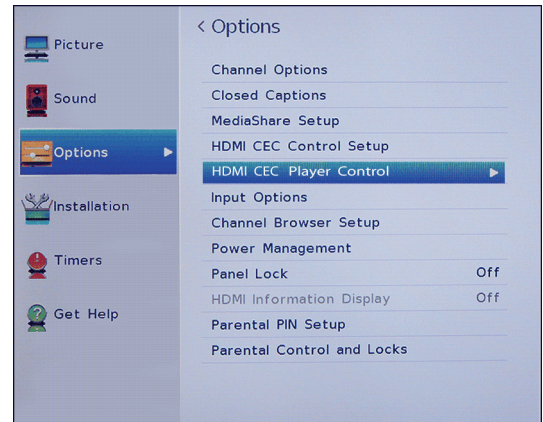

- 3 Highlight **HDMI CEC Player Control**, then press **ENTER**.



- 4 Highlight an option, then press **ENTER**. You can select:
 - **Power**—Turns the selected device on or off.
 - **Root Menu**—Accesses the root menu of the selected device.
 - **Contents Menu**—Accesses the contents list of the device. When you press **ENTER**, the *HDMI CEC Player Control* menu closes.
 - **Setup Menu**—Accesses the setup menu of a selected device.
 - **Top Menu**—Accesses the top menu of a selected device.
 - **Menu**—Accesses the menu of a selected device.
- 5 Press **EXIT** to close the menu.

Using the Media Player

You can connect a USB flash drive to your TV to view photos stored on the flash drive.

This section includes topics about:

- [Supported photo file formats](#)
- [Turning Auto Start on or off](#)
- [Automatically opening the Media Player](#)
- [Manually opening the Media Player](#)
- [Viewing photos](#)
- [Viewing photos in a slideshow](#)

Supported photo file formats

Your TV supports the following photo file formats:

- Data type: JPEG EXIF ver 2.1
- File format: JPEG
- Maximum photo size: 6 MB
- Maximum number of files: 500/folder
- Maximum photo resolution: 4096 × 4096 pixels

Notes

- Connectivity is not guaranteed for all devices.
- Connect the USB flash drive to the TV directly. Do not use a USB Hub.
- You must obtain any required permission from copyright owners to use copyright content.
- Depending on the file size and amount stored on the USB flash drive, it may take some time to load before content is viewable.
- A message appears on-screen when files are loading from the USB flash drive.
- Only limited types of U3 USB devices are supported. We recommend that you not use U3 USB with the Media Player.
- Non-supported characters are replaced with squares.

Turning Auto Start on or off

When **Auto Start** is turned on and you plug a USB flash drive in the **USB** port on your TV, a message asks if you want to start the Media Player.

When **Auto Start** is turned off, you must manually start the Media Player.

- 1 Press **MENU**, press **▲** or **▼** to highlight **Options**, then press **ENTER**.

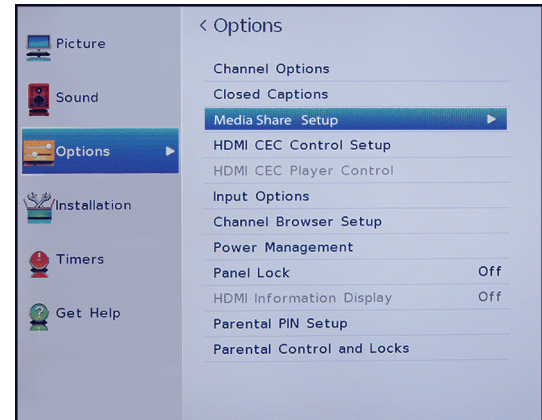

- 2 Highlight **MediaShare Setup**, then press **ENTER**.

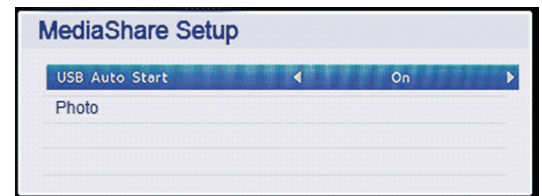

- 3 Highlight **USB Auto Start**, press **◀** or **▶** to select **On** or **Off**.
- 4 Press **EXIT** to close the menu.

Automatically opening the Media Player

Notes

- If **Auto Start** is turned off, you must manually start the Media Player. See [Turning Auto Start on or off](#) on page 49 or [Manually opening the Media Player](#) on page 50.
- If you repeatedly insert and remove the USB flash drive, the message may not appear.
- The Media Player opens even if there are no photo files on the USB flash drive.
- While the Media Player is open, you cannot access the TV menus.

- 1 Make sure that **Auto Start** is turned on. See [Turning Auto Start on or off](#) on page 49.
- 2 Gently insert a USB flash drive into the USB port on your TV. A message asks if you want to start the Media Player.

- 3 Press ◀ or ▶ to select **Yes**, then press **ENTER**. The *MediaShare Setup* menu opens.
- 4 To close the Media Player, press **EXIT**.

Manually opening the Media Player

Note
 If **Auto Start** is turned on, a message asks if you want to start Media Player. See [Automatically opening the Media Player](#) on page 49.

- 1 Gently insert a USB flash drive into the USB port on your TV.
- 2 Press **INPUT**, press ▲ or ▼ to highlight **USB**, the press **ENTER**.
- 3 Highlight **Photo**, then press **ENTER**. The Media Player displays a thumbnail index of the files and folders on the flash drive.
- 4 To close the Media Player, press **EXIT**.

Viewing photos

When you connect a USB flash drive that has photos on it and open the Media Player, a thumbnail index screen opens that shows the files and folders on the flash drive.



To navigate the thumbnail index screen:

- Press ▲ ▼ ◀ or ▶ to highlight a folder or photo, then press **ENTER**.
 - If you select a folder and press **ENTER**, the folder opens and displays thumbnails of the photos in the folder. Press **CH RTN** to return to the previous thumbnail screen or folder.
 - If you select a photo and press **ENTER**, the photo is displayed full-screen.
 - If all the photos do not fit on one screen:
 - Highlight the top left thumbnail, then press ◀ to move to the previous screen.
 - Highlight the bottom right thumbnail, then press ▶ to move to the next screen.

To navigate on a full-screen photo:

- Press ◀ or ▶ to view the previous or next photo.
- Press ▲ to rotate the photo 90° counter-clockwise or press ▼ to rotate the photo 90° clockwise.
- Press **EXIT** to close the Media Player.

To sort the files and folders on the thumbnail screen:

- 1 Press **MENU**, then press ▲ or ▼ to highlight **Sort**.

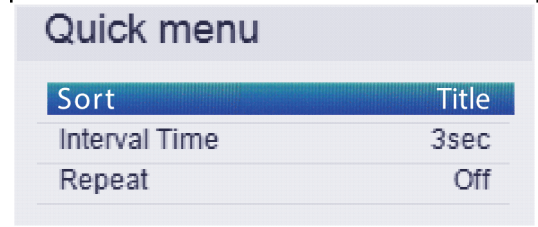

- 2 Press ◀ or ▶ to select **Title**, **New**, or **Old**.
 - **Title**—Sorts by the file and folder name.
 - **New**—Sorts by the file and folder date from the newest to the oldest.
 - **Old**—Sorts by the file and folder date from the oldest to newest.
- 3 Press **CH RTN** to return to the thumbnail screen.

Viewing photos in a slideshow

When viewing photos in a slideshow, you can:

- Skip backward or forward through the photos in the current folder
- Set the time interval between photo displays.
- Repeat the slideshow

To view photos in the slideshow:

- 1 Select a photo, then press **ENTER** to view it full-screen. Press **ENTER** again to start a slideshow in the current folder.
- 2 Press ◀ or ▶ to view the previous or next photo in the slideshow.

To set the time interval:

- 1 With a photo displayed full-screen, press **ENTER**.
- 2 Press **MENU**, then press ▲ or ▼ to highlight **Interval Time**.

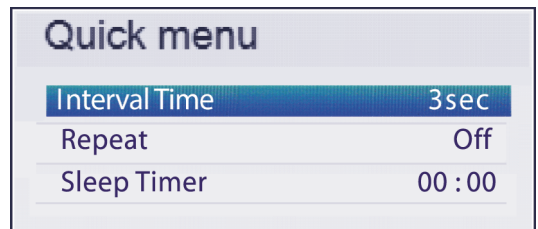

- 3 Press ◀ or ▶ to select the time interval.
- 4 Press **CH RTN** to continue the slideshow.

To set the repeat mode:

- 1 With a photo displayed full-screen, press **ENTER**.
- 2 Press **MENU**, then press **▲** or **▼** to highlight **Repeat**.

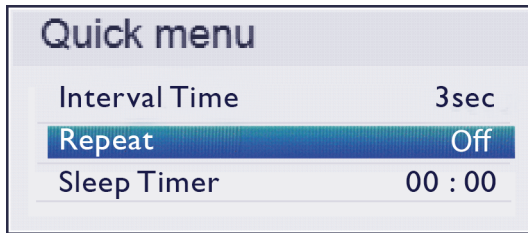

- 3 Press **◀** or **▶** to select **On**.
- 4 Press **CH RTN** to continue the slideshow.

Adjusting the picture

This section covers:

- Adjusting the TV picture
- Adjusting the picture size
- Scrolling the TheaterWide™ picture
- Automatically adjusting the aspect ratio
- Using the 4:3 Stretch
- Freezing the picture

Adjusting the TV picture

You can adjust various settings to improve the quality of the TV picture. Also, you can reset all picture settings to the factory default.

- 1 Press **MENU**, press **▲** or **▼** to highlight **Picture**, then press **ENTER**.

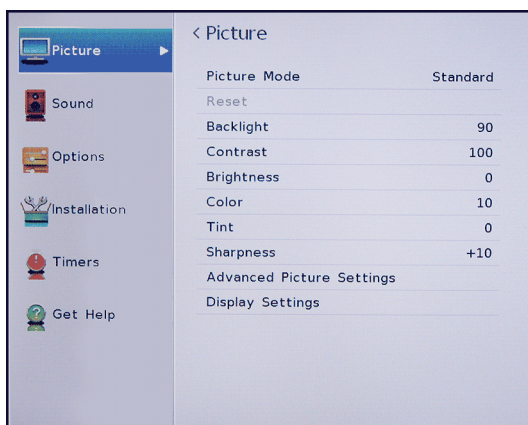

- 2 Highlight an option, then press **ENTER**. You can select:
 - **Picture Mode**—Selects the picture mode. You can select:
 - **Dynamic**—Significantly increases the contrast, color saturation, sharpness, gray scale, and brightness to create more vivid and dynamic images.
 - **Standard**—Uses the default settings.

- **Movie**—Lowers the contrast for a darkened room.
- **Game**—Reduces controller delay for faster video gaming action.
- **PC**—Optimizes the image of a connected computer.

Note

The **PC** option is only available for HDMI. The option is grayed for other input sources.

- **Store**—The **Store** picture mode is only available if you selected **Store Mode** during initial setup. This option is hidden in the Home mode.

Note

When your TV is set to **Store Mode** (during the initial setup or from the *Installation* menu), your TV will always revert to **Store Mode** when you turn it on.

- **Reset**—Resets all picture settings to the factory default.
- **Backlight**—Sets the overall brilliance of the screen.
- **Contrast**—Adjusts the brightness of the light areas of the picture.
- **Brightness**—Adjusts the brightness of the dark areas of the picture.
- **Color**—Adjusts the color intensity of the picture. A low setting may make the color look faded. A high setting may make the color look artificial.
- **Tint**—Adjusts the color balance of the picture. Use this control to make skin tones look more natural.
- **Sharpness**—Adjusts the color detail of images. If you set this control too high, dark images may appear with light or white edges.
- **Advanced Picture Settings**—Opens the *Advanced Picture Settings* menu where you can adjust additional video options.

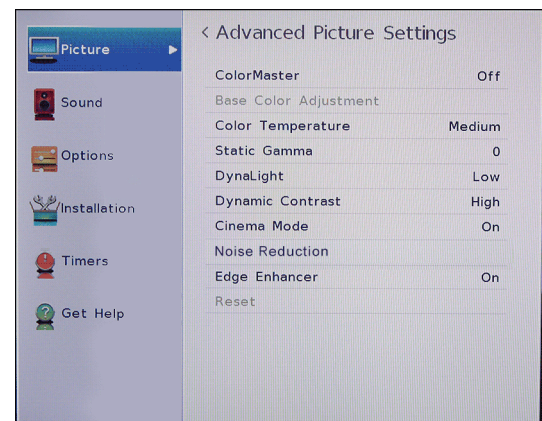

- **ColorMaster**—Lets you adjust standard colors. You can select **On** or **Off**.
 - **Base Color Adjustment**—When **ColorMaster** is turned on, displays a list of base colors you can adjust.
 - A Highlight this option, then press **ENTER**.
 - B Highlight a color, then press **ENTER**.
 - C Press ◀ or ▶ to select **Hue**, **Saturation**, or **Brightness**, then press ▲ or ▼ to adjust the setting.
 - **Color Temperature**—Adjusts the color temperature.
 - A Highlight this option, then press **ENTER**.
 - B Highlight **Cool** (to enhance the blues), **Medium** (to select a neutral color temperature), or **Warm** (to enhance the reds), then press **ENTER**.
 - C Highlight **Red**, **Green**, or **Blue**, then press **ENTER**. Press ◀ or ▶ to adjust the setting.
 - D Press **ENTER**.
 - **Static Gamma**—lets you adjust the levels of black in the picture.
 - A Highlight this option, then press **ENTER**.
 - B Press ◀ or ▶ to decrease or increase the black level detail.
 - **DynaLight™**—Automatically strengthens the black coloring of dark areas in the video according to the level of darkness. You can select **High**, **Low**, or **Off**.
 - **Dynamic Contrast**—Automatically detects changes in picture quality that affect the appearance of your contrast settings and automatically adjusts the video. You can select **High**, **Middle**, **Low**, or **Off**.
 - **Cinema Mode**—Smooths the video motion when watching a movie on a DVD. You can select **On** or **Off**. (This option is available for video with a 480i or 1080i video resolution.)
 - **Noise Reduction**—Reduces picture noise (snow).
 - A Highlight this option, then press **ENTER**.
 - B Highlight **MPEC NR** or **DNR**, then press **ENTER**.
 - C Highlight **High**, **Middle**, **Low**, or **Off**.
 - **Edge Enhancer**—Adjusts the picture to achieve a sharper image. You can select **On** or **Off**.
 - **Reset**—Resets all advanced picture settings to factory defaults.
 - **Display Settings**—Opens the Display Settings menu where you can adjust how the picture is displayed on the screen.
 - A Highlight this option, then press **ENTER**.
 - B Highlight **Auto Aspect**, then press **ENTER**. Press ▲ or ▼ to select **On** or **Off**. See [Automatically adjusting the aspect ratio](#) on page 54.
 - C Highlight **4:3 Stretch**, then press **ENTER**. Press ▲ or ▼ to select **On** or **Off**. See [Using the 4:3 Stretch](#) on page 55.
 - D Highlight **Picture Position**, then press ◀ or ▶ to adjust the vertical picture position. See [Scrolling the TheaterWide™ picture](#) on page 54.
- 3 Press ◀ ▶ ▲ or ▼ to adjust the option or select a setting, then press **ENTER**.
 - 4 Press **EXIT** to close the menu.

Notes

- Picture setting adjustments affects the current video input only. You can adjust the picture quality separately for each input.
- Depending on the **Sharpness** setting, the **Edge Enhancer** effect may be reduced.

Adjusting the picture size

- 1 Press **PIC SIZE**.
- 2 Do one of the following:
 - Repeatedly press **PIC SIZE**.
 - Press the corresponding number button (0-5) while the *Picture Size* menu is displayed. You can select **Full**, **TheaterWide 1**, **TheaterWide 2**, **TheaterWide 3**, **4:3**, **Native**, **Normal**, or **Dot by Dot**.
 - Repeatedly press **▲** or **▼**.
- 3 Press **ENTER** or **EXIT** to close the menu.

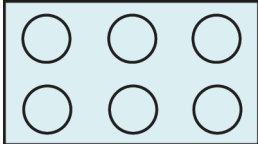
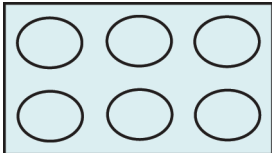
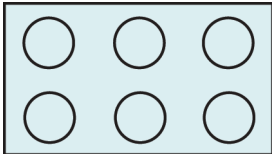
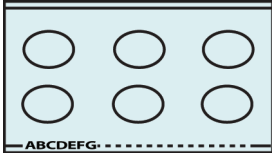
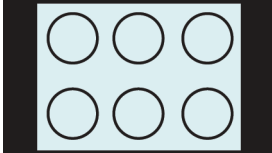
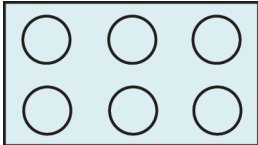
Picture size	Example
Full Displays the picture in a 16:9 format (aspect ratio). If the picture is in a 4:3 format, the picture is stretched horizontally to fill the width of the screen but is not stretched vertically. The edges of the picture may be hidden.	
TheaterWide 1 The center of the picture remains close to its original proportion, but the left and right edges are stretched horizontally to fill the screen.	
TheaterWide 2 This setting is for viewing letter box (4:3) programs.	
TheaterWide 3 This setting is for viewing letter box programs with subtitles. The top and bottom edges of the picture are hidden.	
4:3 Displays the picture in letter box format. Some program formats will display with sidebars and/or bars at the top and bottom.	
Native: If the program is a 1080i, 1080p, 720p, 480i (HDMI®), or 480p (HDMI®) program, the picture is scaled to display the entire picture within the borders of the screen (no overscanning). This picture size is especially useful for viewing external HD sources, such as DVD movies, video games, or computer graphics.	

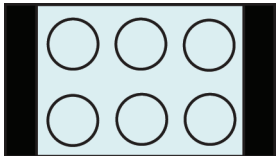
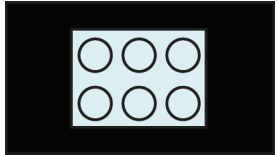
Picture size	Example
Normal Displays the image in the original aspect ratio. You may see black bars if the original content is not widescreen. This setting is for viewing VGA, SVGA, XGA, WXGA, and SXGA sources.	
Dot by Dot Dot by Dot is a non-scaling display. Depending on the input signal format (VGA, for example), the picture may appear with sidebars and/or bars at the top and bottom. This setting is for viewing VGA, SVGA, XGA, WXGA, and SXGA sources. This option is only available when the video input source is HDMI and the video signal is VGA, SVGA, XGA, WXGA, or SXGA.	

Notes

- Some of the picture sizes may not be available depending on the receiving signal format (those will be grayed out in the *Picture Size* screen).
- If you select a TheaterWide™ picture size, the top and bottom edges of the picture (including subtitles or captions) may be hidden. To view these edges, try adjusting the **Picture Position**, viewing the program in **4:3** or **Full**, or scroll the picture. See [Scrolling the TheaterWide™ picture](#) on page 54.
- The **Native** mode is supported only for HDMI® (1080i, 1080p, 720p, 480i, and 480p), COMPONENT (1080i and 720p), and ANT/CABLE (digital) inputs (1080i, 1080p, and 720p).
- In **Native** mode, the picture's border may be hidden, displayed in black, or noisy, depending on the input signal.

Scrolling the TheaterWide™ picture

You can set separate scroll settings for the **TheaterWide 2** and **TheaterWide 3** picture size modes for each input. For more information about pictures sizes, see [Adjusting the picture size](#) on page 53.

- 1 Press **MENU**, press **▲** or **▼** to highlight **Picture**, then press **ENTER**.



- 2 Highlight **Display Settings**, then press **ENTER**.

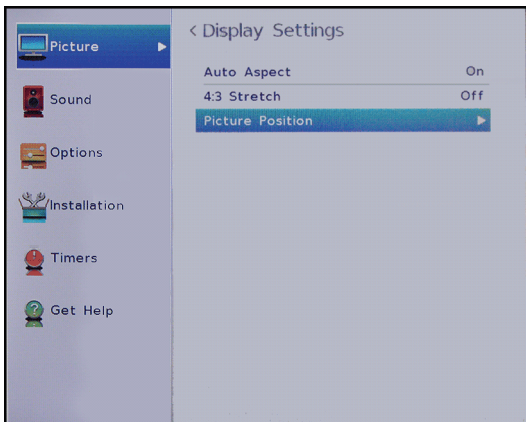

- 3 Highlight **Picture Position**, then press **ENTER**.

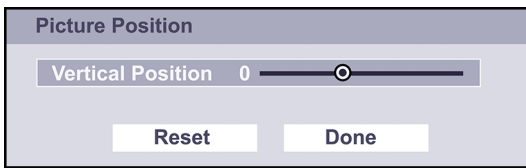

- 4 Press **◀** or **▶** to move the picture up and down as needed, then press **ENTER**. To save the new settings, press **▲** or **▼** to highlight **Done**, then press **ENTER**.

OR

To revert to the factory defaults, highlight **Reset** then press **ENTER**.

- 5 Press **EXIT** to close the menu.

Automatically adjusting the aspect ratio

When the **Auto Aspect** option is set to **On**, your TV automatically selects the picture size when one of the following input sources is received:

- 480i, 480p, 720p, 1080i digital signal from the **ANT/CABLE IN** jack
- 480i, 480p, 720p, 1080i, 1080p, or VGA (60Hz) signal from an **HDMI** jack

Aspect Ratio of Signal Source	Auto Aspect is set to (On)
4:3 Normal	4:3
4:3 Letter Box	TheaterWide 2
16:9	Full
Not defined (no ID-1 data or HDMI® aspect data)	The current picture size you selected, see Adjusting the picture size on page 53.

- 1 Press **MENU**, press **▲** or **▼** to highlight **Picture**, then press **ENTER**.



- 2 Highlight **Display Settings**, then press **ENTER**.

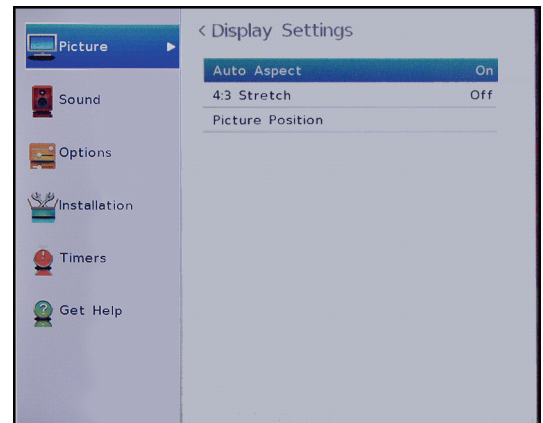

- 3 Highlight **Auto Aspect**, then press **ENTER**.

- 4 Highlight **On**, then press **ENTER**. (To turn off **Aspect Ratio**, select **Off**.)
- 5 Press **EXIT** to close the menu.

Using the 4:3 Stretch

When 4:3 Stretch is turned on, your TV displays 4:3 programs as a full-screen picture.

- 1 Press **MENU**, press **▲** or **▼** to highlight **Picture**, then press **ENTER**.

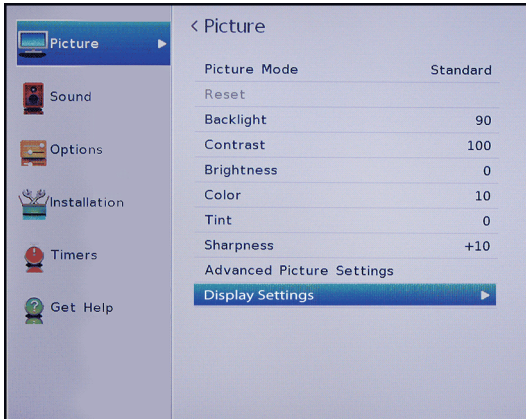

- 2 Highlight **Display Settings**, then press **ENTER**.

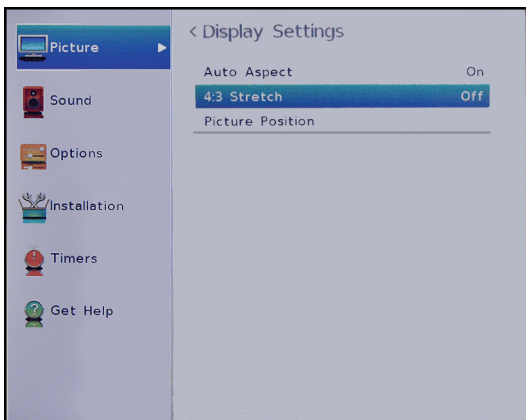

- 3 Highlight **4:3 Stretch**, then press **ENTER**.
- 4 Highlight **On**, then press **ENTER**. (To turn off **4:3 Stretch**, select **Off**.)
- 5 Press **EXIT** to close the menu.

Freezing the picture

You can freeze the picture while you are watching TV. The audio continues to play while the picture is frozen. When you unfreeze the picture, the video resumes to playing.

- 1 When watching the TV, press **FREEZE**.
- 2 To unfreeze the picture, press **FREEZE** or any other button.

Notes

- If your TV is left in freeze mode for more than 15 minutes, freeze mode automatically turns off and your TV returns to normal video.
- Using the freeze function for any purpose other than your private viewing may be prohibited under the Copyright Laws of the United States and other countries, and may subject you to civil and criminal liability.

Adjusting the sound

This section covers:

- [Adjusting sound settings](#)
- [Playing TV audio only](#)

Adjusting sound settings

You can adjust sound settings to improve the sound quality.

- 1 Press **MENU**, press **▲** or **▼** to highlight **Sound**, then press **ENTER**.

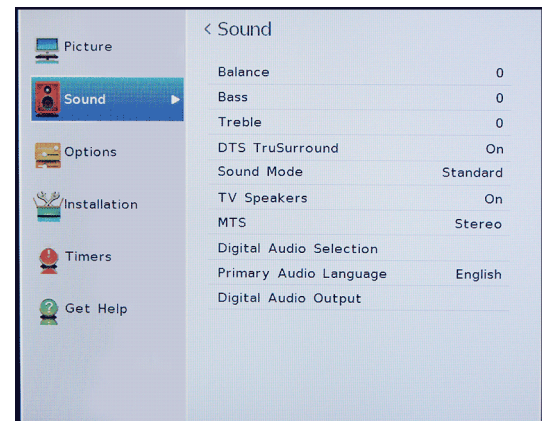

- 2 Highlight an option, then press **ENTER**. You can select:
 - **Balance**—Adjusts the balance between the left and right audio channels.
 - **Bass**—Adjusts the low sounds.
 - **Treble**—Adjusts the high sounds.
 - **DTS TruSurround**—Delivers clear, crisp, and natural sound over front facing speaker configurations, complete with rich bass, high frequency detail, and clear dialog. You can select **On** or **Off**.

- **Sound Mode**—Selects the sound mode. You can select **Standard**, **Music**, **Movie**, or **Clear Voice**.
- **TV Speakers**—Turns your TV’s speakers on or off. You can select:
 - **On**—Keeps the TV speakers on when you connect a device to the  jack.
 - **Off**—Turns off the TV speakers.
 - **Auto**—Turns off the TV speakers when you connect a device to the  jack.
- **MTS**—(Analog channels received through the **ANT / CABLE IN** jack only) Selects the audio mode. You can select:
 - **Stereo**—Select this option for programs broadcast in stereo. You can typically leave your TV in Stereo mode because **Stereo** outputs the type of sound being broadcast (stereo or mono).
 - **Mono**—Select this option if there is noise or static on weak stereo broadcasts.
 - **SAP**—Select this option to listen to a secondary audio program, if available. If you select this option and no secondary audio program is available, you may not hear sound. Change the **MTS** option to **Stereo**.
- **Digital Audio Selection**—Lets you conveniently switch between audio tracks on a digital channel (when available). This option temporarily overrides the **Primary Audio Language** option on the *Sound* menu.
- **Primary Audio Language**—Selects the language for digital channels.
- **Digital Audio Output**—Opens the *Digital Audio Output* menu where you can adjust digital audio.

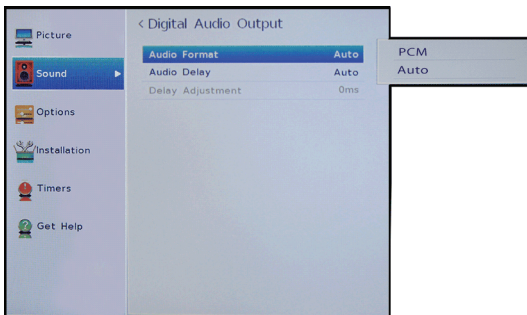

- **Audio Format**—Selects the digital audio format sent to an external audio system. You can select:
 - **PCM** (to convert and output sound as PCM (pulse-code modulation) format).
 - **Auto** (to pass through the original digital sound).

- **Audio Delay**—Fine tunes the audio when it is not in sync with the video.
- **Delay adjustment**—Lets you set the amount of delay to manually sync the audio with the video.

- 3 Press **◀ ▶ ▲ ▼** to adjust the option or select a setting, then press **ENTER**.
- 4 Press **EXIT** to close the menu.

Playing TV audio only

You can turn off the picture on your TV and listen to the program audio only.

- 1 Press **MENU**, press **▲** or **▼** to highlight **Options**, then press **ENTER**.

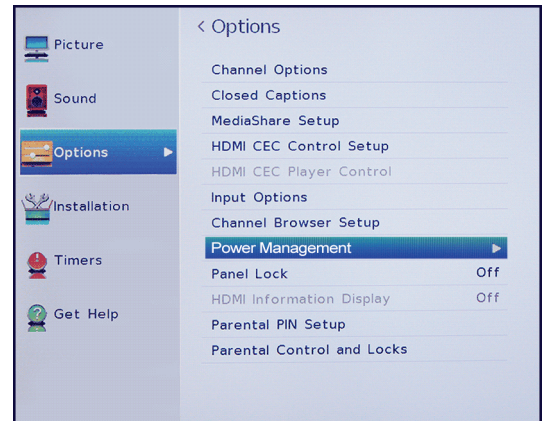

- 2 Highlight **Power Management**, then press **ENTER**.

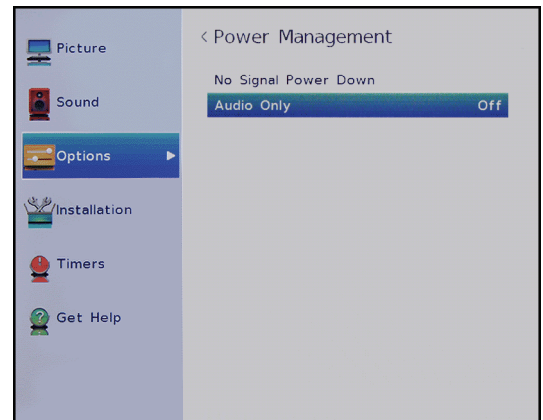

- 3 Highlight **Audio Only**, then press **ENTER**.

- Highlight **On** or **Off**, then press **ENTER**.
- Press **EXIT** to close the menu.

Notes

- The picture turns off in about five seconds.
- Press any button to turn on the picture for about five seconds.
- To exit audio only mode, repeat this task and select **Off**.

Using the Channel Browser

This section includes topics about:

- Channel Browser overview
- Setting up the Channel Browser
- Selecting a channel or input in the Channel Browser
- Adding and clearing channels and inputs in the History list

Channel Browser overview

The Channel Browser lets you:

- Navigate through channels and inputs
- Tune to recently viewed channels and inputs in the Channel Browser History list
- Tune to favorite channels in your Favorite channel list

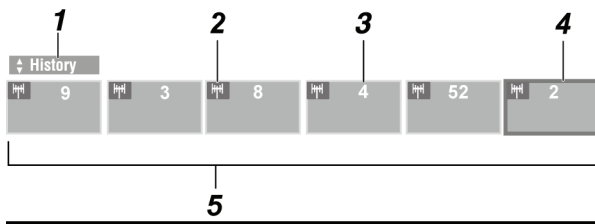

#	Item
	Indicates which list is currently displayed. Available lists include: <ul style="list-style-type: none"> History ANT/CABLE Inputs Favorites HDMI® CEC
1	
2	Indicates whether an item is a channel or input type.
3	Indicates the channel or input currently being viewed.
4	Indicates the channel or input currently highlighted in the browser.
5	Shows the channels stored in the current list.

Setting up the Channel Browser

- Press **MENU**, press **▲** or **▼** to highlight **Options**, then press **ENTER**.

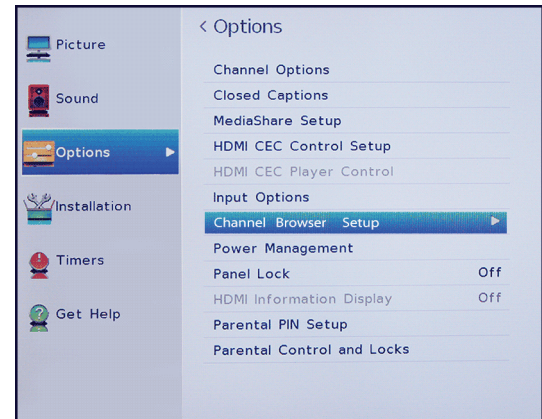

- Highlight **Channel Browser Setup**, then press **ENTER**.

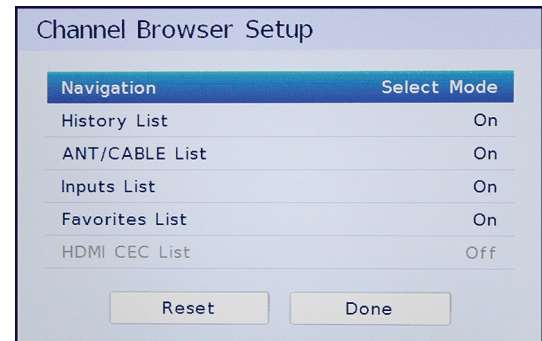

- Press **▼** to highlight **Navigation**, then press **◀** or **▶** to select **Browse Mode** or **Select Mode**.
 - Browse Mode**—When you highlight a channel or input, your TV automatically switches to the channel or input.
 - Select Mode**—When you highlight a channel or input, you must press **ENTER** to switch to the channel or input.
- Highlight a list, then press **◀** or **▶** to select **On** or **Off**. When a list is turned on, you can select the list in the Channel Browser. You can select:
 - History List**—Shows all the channels and inputs you have selected. The History list is cleared each time you turn off your TV.
 - ANT/CABLE List**—Shows a list of the channels you can view from a device connected to the **ANT/CABLE IN** jack on your TV (an antenna or cable TV with no box). If you want to view only the channels with a signal, you must scan for available channels. If you did not scan for channels when you set up your TV for the first time, see [Automatically scanning for channels](#) on page 59.
 - Inputs List**—Shows the available video inputs.

- **Favorites List**—Shows the channels and inputs in your Favorites list. See [Setting up the Favorites list](#) on page 61.
- **HDMI CEC List**—Shows the HDMI CEC devices connected to your TV. To view the HDMI CEC list, **Enable HDMI CEC Control** in the *HDMI CEC Control Setup* menu must set to **On**. See [Turning HDMI-CEC Control on or off](#) on page 45.

5 Press **EXIT** to close the menu.

Selecting a channel or input in the Channel Browser

The Channel Browser lets you select a channel or input from one of the Channel Browser lists. You have to set up the Channel Browser before you can use it. See [Setting up the Channel Browser](#) on page 57.

1 Press **NEXT CB** or **BACK CB** to open the Channel Browser.



2 Press **▲** or **▼** to select the list you want to use, then press **◀** or **▶** to select an item.

Notes

- The Channel Browser opens with the *Favorites* list selected by default. If you select another list, the next time you open the Channel Browser, it opens with that list selected.
- If all the lists are turned off, pressing **NEXT CB**, **BACK CB**, or **FAV** does not open the Channel Browser. For information about turning lists on and off, see [Setting up the Channel Browser](#) on page 57.

3 Press **NEXT CB** or **BACK CB** to highlight a channel or input.

If you selected **Select Mode** when you set up the Channel Browser, press **ENTER**. Your TV switches to the channel or input you highlighted.

If you selected **Browse Mode** when you set up the Channel Browser, you do not have to press **ENTER**. Your TV switches to the channel or input you highlighted.

4 Press **EXIT** to close the Channel Browser.

Adding and clearing channels and inputs in the History list

Items are added to the *History* list when you:

- Tune to a channel using the Channel Browser.
- Tune to a channel using the number buttons
- Tune to a channel using **CH▲** or **CH▼**
- Switch to a different video input source

When you tune to a channel or switch to a different video input, the Channel Browser adds the channel or input to the *History* list and displays it on the right side of the Channel Browser. Previously tuned channels and inputs are shifted to the left, and eventually move off the left side. To access previously tuned channels or video input sources, press **BACK CB** to scroll backward through the list.

Any channel or input that you tune to repeatedly is not repeated in the *History* list. Instead the channel or input is moved to the end of the list on the right side of the Channel Browser.

Note

If you try to tune to a channel or input that cannot be selected, your TV automatically tunes to the previously viewed channel or input.

Items are cleared from the *History* list when you:

- Turn off your TV
- Change the configuration of the **ANT / CABLE IN** jack. See [Setting up the ANT / CABLE IN jack](#) on page 40.

Changing channel settings

This section covers:

- Automatically scanning for channels
- Manually adding channels to the channel list
- Hiding channels
- Setting up the Favorites list
- Tuning to a favorite channel or input
- Deleting a favorite channel or input

Automatically scanning for channels

When you scan for channels, your TV searches for channels with signals and stores the channel information in the channel list. When you press **CH ▲** or **CH ▼**, your TV goes to the next or previous channel in the channel list. The channel scan may take several minutes.

Note

When you scan for channels, your TV erases any channels already stored in the channel list.

If a channel is not stored in the channel list, you can:

- Use the number button on the remote control to enter the channel number.
- Manually add the channel to the channel list. See [Manually adding channels to the channel list](#) on page 60.

- 1 Make sure that you have set up the **ANT / CABLE IN** jack before programming channels. See [Setting up the ANT / CABLE IN jack](#) on page 40.
- 2 Press **MENU**, press **▲** or **▼** to highlight **Installation**, then press **ENTER**.

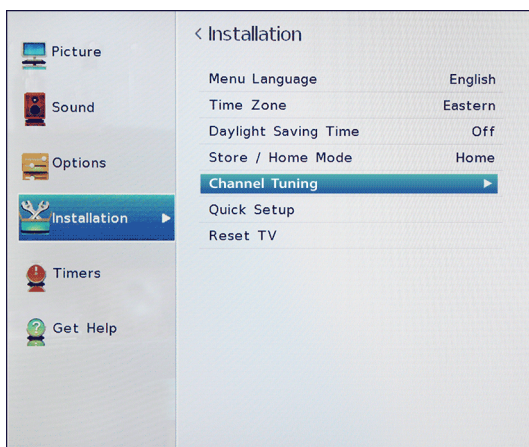

- 3 Highlight **Channel Tuning**, then press **ENTER**.

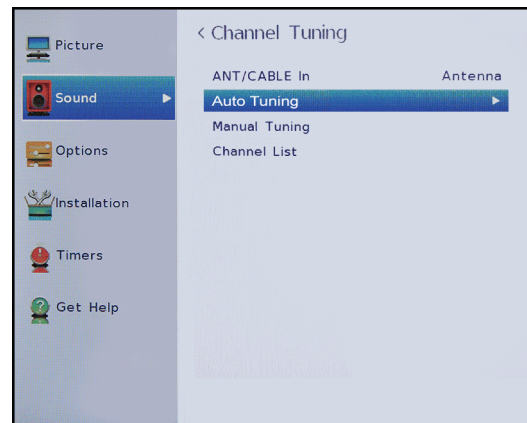

- 4 Highlight **Auto Tuning**, then press **ENTER**. Press **ENTER** again to start the scan.
- 5 Use the number buttons to enter your 4-digit PIN, then press **ENTER** twice. If you have not created a PIN, see [Setting a new PIN](#) on page 62. Your TV scans for available channels. The scan may take several minutes.

Note

You can press **EXIT** to stop the auto channel search, but you will need to run the auto channel search again to create a channel list.

- 6 When the scan is complete, press **EXIT** to close the menu. Your TV tunes to the first scanned channel.

Manually adding channels to the channel list

Channels with weak signals may not be added to the channel list when you scan for channels. You can manually add a channel to the channel list if you know the channel number.

- 1 Press **MENU**, press **▲** or **▼** to highlight **Installation**, then press **ENTER**.

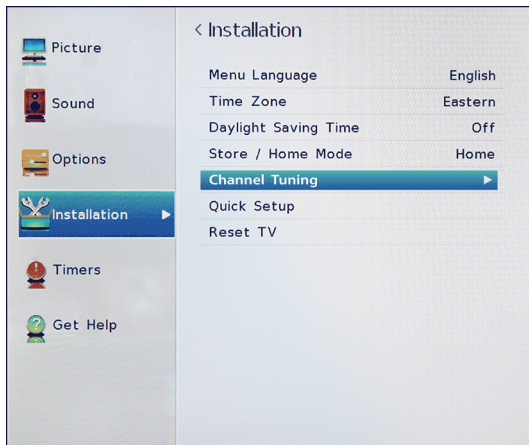

- 2 Highlight **Channel Tuning**, then press **ENTER**.

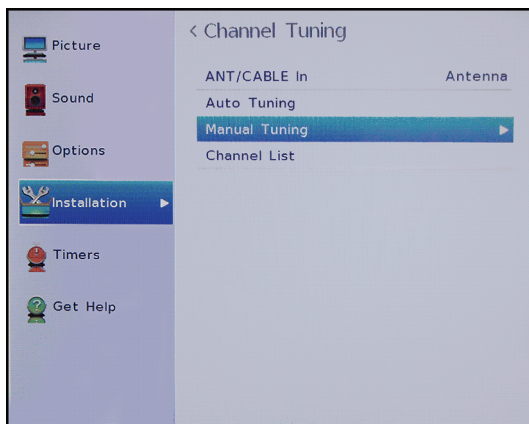

- 3 Highlight **Manual Tuning**, then press **ENTER**.

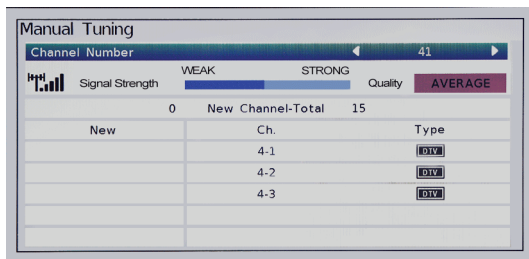

- 4 Use the number buttons on the remote control to enter the channel number, then press **ENTER**.
- 5 Press **ENTER** to start manual tuning.
- 6 Press **EXIT** to close the menu.

Hiding channels

You can hide channels in the channel list. When you press **CH ▲** or **CH ▼**, your TV skips the hidden channels. Hiding a channel also hides the channel in the Channel Browser.

You can still tune to a hidden channel by pressing the number buttons for the channel. If you tune to a hidden channel, the channel appears in the *History* list.

- 1 Press **MENU**, press **▲** or **▼** to highlight **Options**, then press **ENTER**.

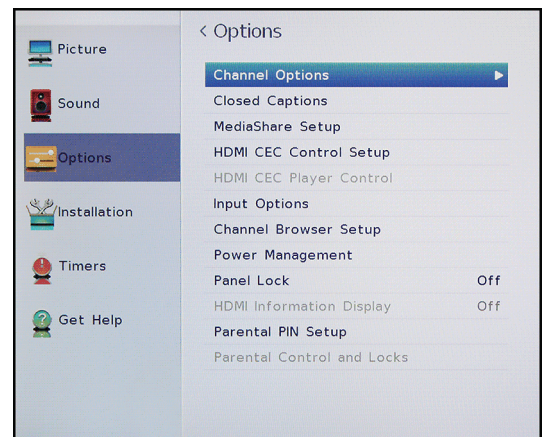

- 2 Highlight **Channel Options**, then press **ENTER**.

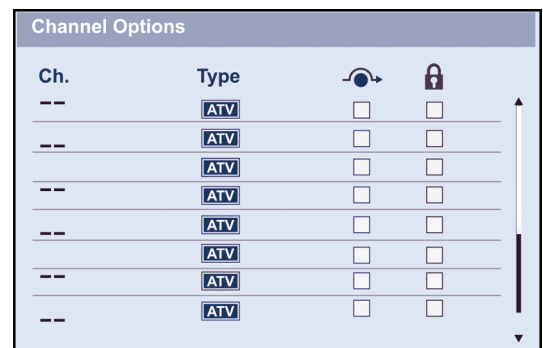

- 3 Highlight a channel you want to hide, then press **ENTER**. A check appears in the box next to the channel.

Notes

- Channels labeled ATV are analog channels. Channels labeled DTV are digital channels.
- To un-hide a channel, highlight the channel, then press **ENTER** to remove the check.
- You can also lock specific channels so that they cannot be tuned until you unlock them. See [Locking channels](#) on page 66.

- 4 Press **EXIT** to close the menu.

Setting up the Favorites list

You can create a list of favorite channels and inputs. You can quickly browse through your favorites by pressing **FAV**, then selecting a channel or input from the list.

- 1 Tune to the channel or input you want to add to the favorites list.
- 2 Press and hold **FAV** for about three seconds. The channel or input is added to your favorite channels list.

Notes

- The channel or input is added to the beginning of the *Favorites* list on the left side of the Channel Browser.
- If the *Favorites* list is not turned on in the Channel Browser, pressing **FAV** does not open the Favorites list. For information about turning lists on and off, see [Setting up the Channel Browser](#) on page 57.

Tuning to a favorite channel or input

- 1 Press **FAV** to open the *Favorites* list.



- 2 Press **NEXT CB** or **RIGHT CB** to highlight a channel or input, then press **ENTER**.
- 3 Press **EXIT** to close the list.

Deleting a favorite channel or input

- 1 Press **FAV** to open the *Favorites* list.



- 2 Press **NEXT CB** or **RIGHT CB** to highlight the channel or input you want to delete, then press — for about three seconds.
- 3 Press **EXIT** to close the *Favorites* list.

Setting parental controls

Parental controls let you prevent your children from watching inappropriate material on TV. When set, parental controls read the rating of the program (with some exceptions, such as news and sports) and deny access to programs that exceed the ratings level you select.

Parental controls let you:

- Set ratings for TV programs and movies so you can prevent your children from watching inappropriate material on TV
- Lock video input sources
- Set a timer to limit how long you can play a game
- Lock the control buttons on your TV.

Note

To watch blocked programs, you must enter a PIN.

Parental control topics include:

- [Setting a new PIN](#)
- [Changing or deleting the PIN](#)
- [Blocking TV programs and movies \(for USA region\)](#)
- [Downloading rating information \(for USA region\)](#)
- [Temporarily unlocking programs](#)
- [Locking video inputs](#)
- [Locking channels](#)
- [Setting the GameTimer™](#)
- [Locking control buttons on your TV](#)

Setting a new PIN

A PIN is necessary for some menus. The *Parental Control and Locks* menu is grayed out if no PIN has been set.

- 1 Press **MENU**, press **▲** or **▼** to highlight **Options**, then press **ENTER**.

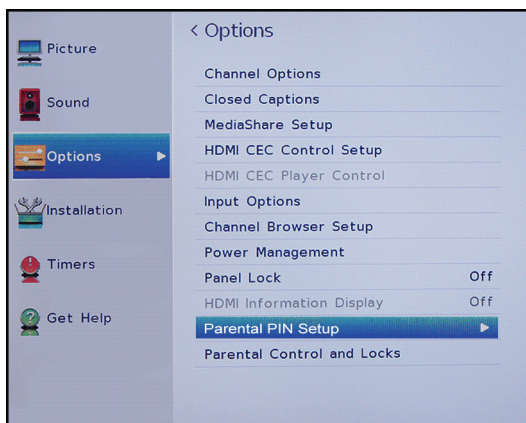

- 2 Highlight **Parental PIN Setup**, then press **ENTER**.

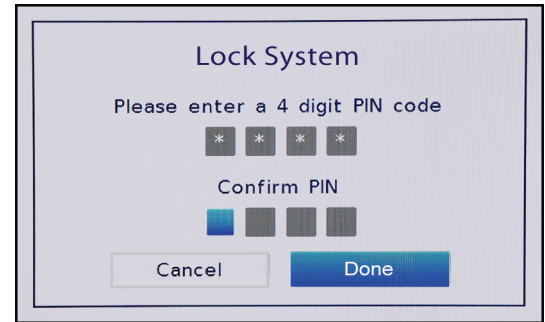

- 3 Use the number buttons to enter a 4-digit PIN, enter the code again to confirm. then press **ENTER**. The *Parental PIN Setup* menu opens.
- 4 Press **EXIT** to close the menu.

Note

If you forget your PIN, open the screen where you enter your PIN, then press **INFO** four times within five seconds. The PIN is cleared and you can enter a new PIN.

Changing or deleting the PIN

- 1 Press **MENU**, press **▲** or **▼** to highlight **Options**, then press **ENTER**.

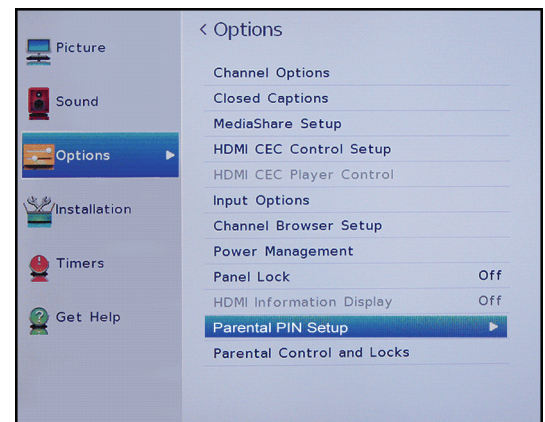

- 2 Highlight **Parental PIN Setup**, then press **ENTER**.



- Use the number buttons to enter your 4-digit PIN, then press **ENTER**.

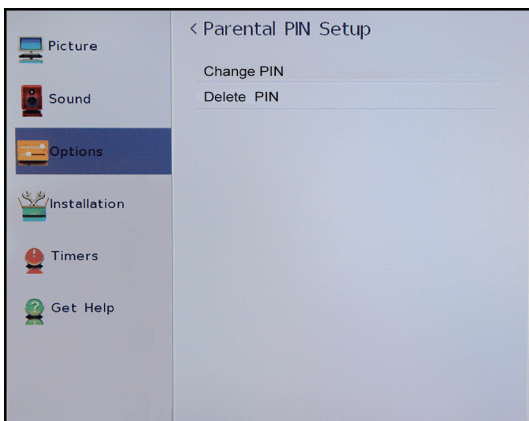

- Highlight **Change PIN** or **Delete PIN**, then press **ENTER**.
- If you select **Change PIN**, enter your new PIN, then enter it again.
OR
If you select **Delete PIN**, press ◀ or ▶ to select **Yes**, then press **ENTER**.
- Press **EXIT** to close the menu.

Blocking TV programs and movies (for USA region)

Some TV programs and movies include ratings that classify the content of the program as unsuitable for younger viewers. Your TV detects the ratings and blocks the programs and movies according to the ratings you select.

Notes

- You must create a PIN before you can block TV programs and movies. See [Setting a new PIN](#) on page 62.
- To view a program or movie rating, tune to the program or movie, then press **INFO**.

TV rating levels

U.S. TV ratings

TV-MA	Mature audiences only. May contain: <ul style="list-style-type: none"> L—Crude or indecent language S—Explicit sexual activity V—Graphic violence
TV-14	Parental guidance strongly suggested. May contain: <ul style="list-style-type: none"> D—Intensely suggestive dialog L—Strong, coarse language S—Intense sexual situations V—Intense violence
TV-PG	Parental guidance suggested. May contain: <ul style="list-style-type: none"> D—Some suggestive dialog L—Infrequent coarse language S—Some sexual situations V—Moderate violence
TV-G	General audiences
TV-Y7	Suitable for children 7 and older.
TV-Y7FV	Note: Programs in which fantasy violence may be more intense or more combative than other programs in this category are designated TV-Y7FV.
TV-Y	Suitable for all children.

Movie rating levels

U.S. movie (MPAA) ratings

X	Adults only
NC-17	Not suitable for children under 17
R	Restricted (Under 17 requires accompanying parent or adult)
PG-13	Parents Strongly Cautioned (Some material may be inappropriate for children under 13)
PG	Parental guidance suggested
G	General audiences (Appropriate for all ages)
None Rated	Content is not rated. Selecting this option may block emergency messages.

- 1 Press **MENU**, press **▲** or **▼** to highlight **Options**, then press **ENTER**.

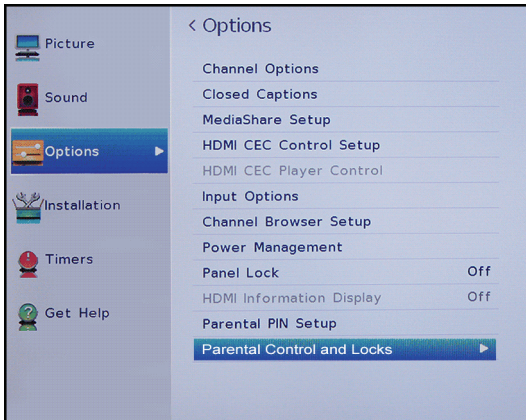

- 2 Highlight **Parental Control and Locks**, then press **ENTER**.

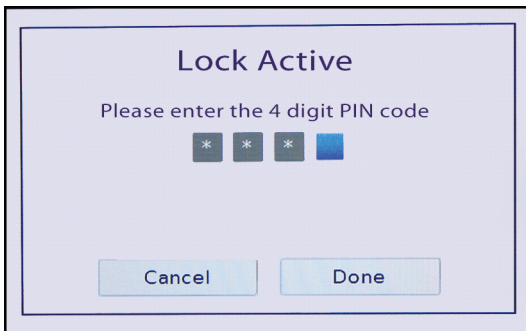

- 3 Use the number buttons to enter your 4-digit PIN, then press **ENTER**.

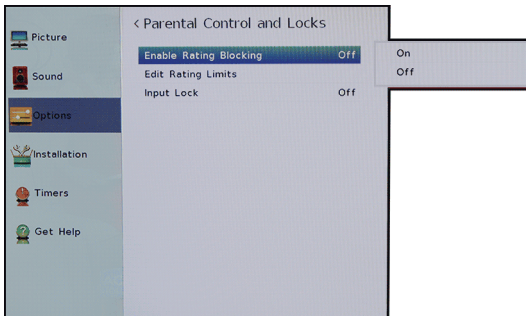

- 4 Highlight **Enable Rating Blocking**, then press **ENTER**.
- 5 Highlight **On**, then press **ENTER**.

- 6 Press **▼** to highlight **Edit Rating Limits**, then press **ENTER**.

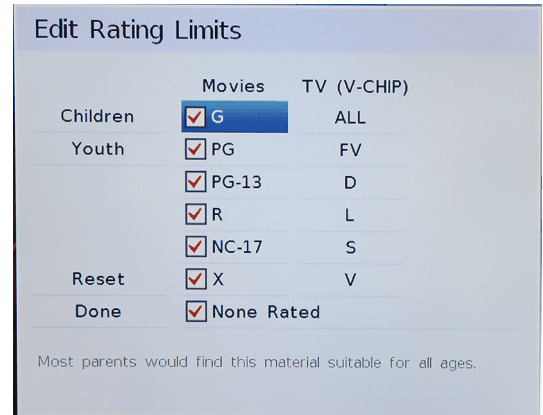

- 7 Press **▲** **▼** **◀** or **▶** to highlight a rating then press **ENTER**.

Notes

- As you highlight a rating, a definition for the rating appears at the bottom of the screen.
- A blocked rating has an **X** next to it.

- 8 When you have finished, highlight **Done**, then press **ENTER** to save your changes.
- 9 Press **EXIT** to close the menu.

Downloading rating information (for USA region)

In the future, an additional rating system may become available for use in selectively blocking TV programs and movies.

The currently tuned station must be receiving a digital signal before an additional rating system can be downloaded.

- 1 Tune to the channel you want to download ratings for.
- 2 Press **MENU**, press **▲** or **▼** to highlight **Options**, then press **ENTER**.

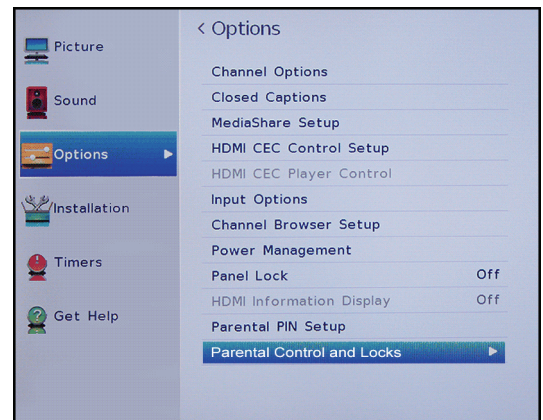

- 3 Highlight **Parental Control and Locks**, then press **ENTER**.

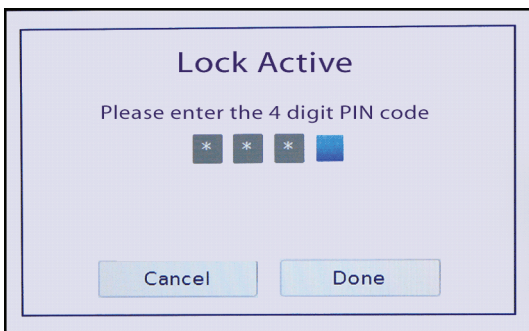

- 4 Use the number buttons to enter your 4-digit PIN, then press **ENTER**.

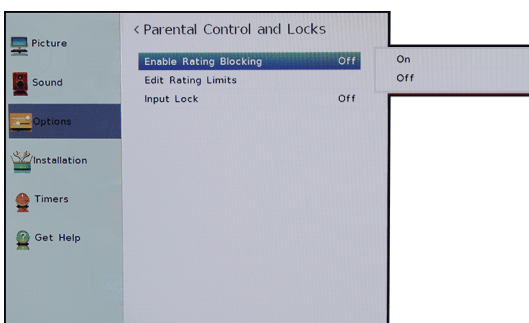

- 5 Highlight **Enable Rating Blocking**, then press **ENTER**.
- 6 Highlight **On**, then press **ENTER**.
- 7 Press **▼** to highlight **Edit Rating Limits**, then press **ENTER**.
- 8 Highlight **Alt RS**, then press **ENTER**.

Notes

- The **ALT RS** option is only available if an additional rating system is currently available.
- Your TV may take several minutes to download the additional rating system.
- The information displayed in the *Alternate Ratings* screen depends on rating system available at the time of download.

- 9 Press **▲ ▼ ◀ ▶** to highlight a rating then press **ENTER**.

Notes

- A blocked rating has an **X** next to it.
- You can only download the additional rating system one time.
- To view a program or movie rating, tune to the program or movie, then press **INFO**.
- You will not be able to download any updates to the rating system should such updates become available.
- The available rating information is controlled by the broadcaster. Content and format may vary.

- 10 When you have finished, highlight **Done**, then press **ENTER**.
- 11 Press **EXIT** to close the menu.

Temporarily unlocking programs

If you try to tune to a program that exceeds the rating limits you have set, your TV enters program lock mode and a warning message appears on the screen. You can temporarily unlock the program.

- 1 Press **MUTE**.
- 2 Enter your four-digit PIN, then press **ENTER**.

The program is unlocked and the normal picture appears. The program is locked again when you change the channel.

Locking video inputs

You can use the Input Lock option to lock the video inputs (**AV**, **COMPONENT**, **HDMI 1**, **HDMI 2**, and **HDMI 3**).

- 1 Press **MENU**, press **▲** or **▼** to highlight **Options**, then press **ENTER**.

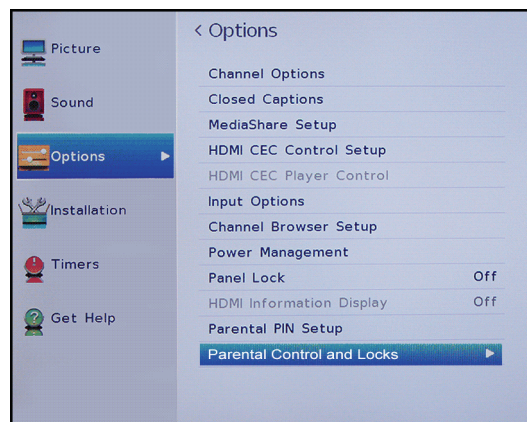

- 2 Highlight **Parental Control and Locks**, then press **ENTER**.

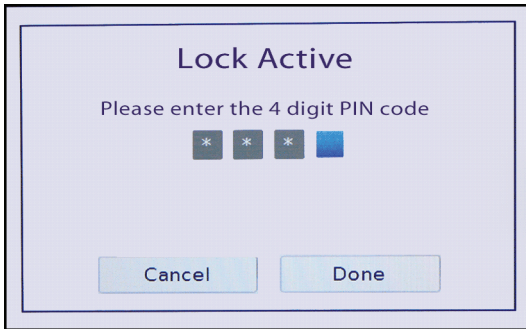

- 3 Use the number buttons to enter your 4-digit PIN, then press **ENTER**.

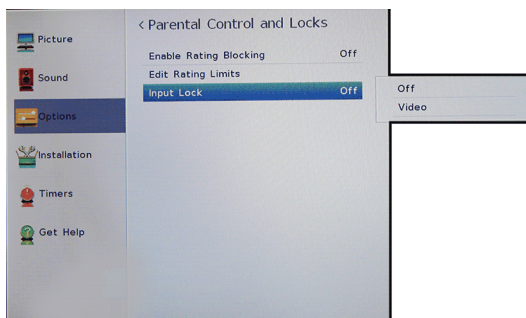

- 4 Press **▼** to highlight **Input Lock**, then press **ENTER**.
- 5 Highlight a video input locking level, then press **ENTER**. You can select:
 - **Video**—Locks **AV**, **COMPONENT**, **HDMI 1**, **HDMI 2**, and **HDMI 3**.
 - **Off**—Unlocks all video inputs.
- 6 Press **EXIT** to close the menu.

Locking channels

Note

You must create a PIN before you can block channels. See [Setting a new PIN](#) on page 62.

- 1 Press **MENU**, press **▲** or **▼** to highlight **Options**, then press **ENTER**.

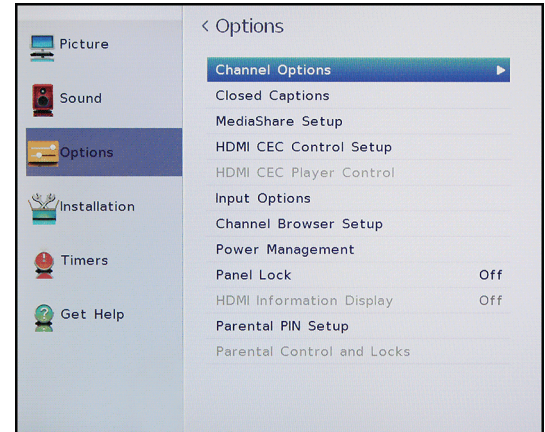

- 2 Highlight **Channel Options**, then press **ENTER**.

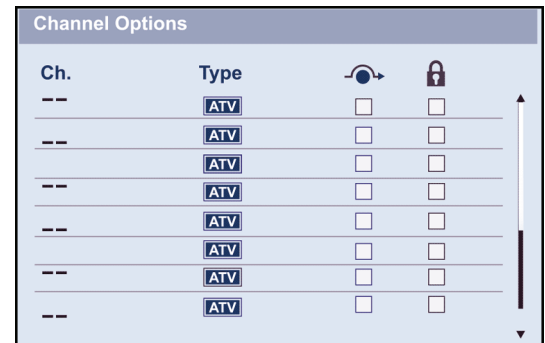

- 3 Highlight a channel, press **◀** or **▶** to move to the column with the padlock icon, then press **ENTER**.

Notes

- Channels labeled **ATV** are analog channels.
- Channels labeled **DTV** are digital channels.

- 4 Use the number buttons to enter your 4-digit PIN. A check appears in the locked column next to the channel.

Note

To unlock a channel, highlight the channel, then press **ENTER** to remove the check.

- 5 Press **EXIT** to close the menu.

Setting the GameTimer™

You can use the GameTimer™ to set a time limit for playing a video game (30–120 minutes). When the GameTimer expires, your TV locks out the input source for the video game device.

- 1 Press **MENU**, press **▲** or **▼** to highlight **Timers**, then press **ENTER**.

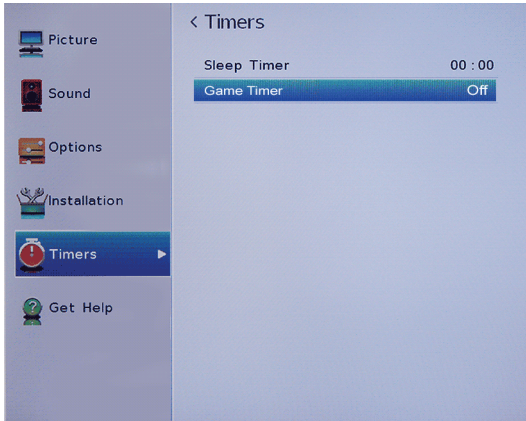

- 2 Highlight **Game Timer**, then press **ENTER**.

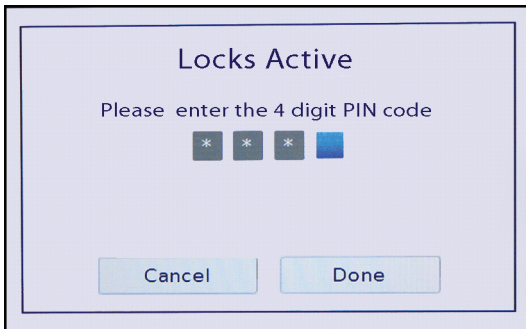

- 3 Use the number buttons to enter your 4-digit PIN, then press **ENTER**.
- 4 Highlight the amount of time you want to let the game run before it turns off, then press **ENTER**. You can select **Off**, **30 min**, **60 min**, **90 min**, or **120 min**.

Note

To turn off the game timer, select **Off**.

- 5 Press **EXIT** to close the menu.

Notes

- A message appears when 10 minutes, 3 minutes, and 1 minute are remaining.
- If your TV loses power with time remaining, your TV enters input lock mode when power is restored (as if the GameTimer had been activated). To resume use, you must deactivate the input lock. See [Locking video inputs](#) on page 65.

Locking control buttons on your TV

You can lock the buttons on the side of your TV to keep someone from changing your settings or changing channels. When **Panel Lock** is set to **On**, none of the buttons on your TV work except the **POWER** button.

You still use the remote control to control your TV.

- 1 Press **MENU**, press **▲** or **▼** to highlight **Options**, then press **ENTER**.

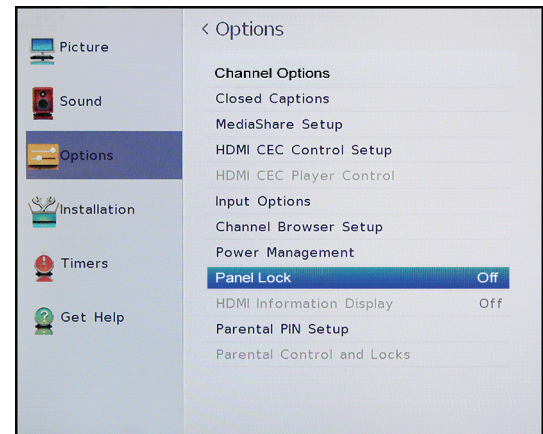

- 2 Highlight **Panel Lock**, then press **ENTER**.



- Use the number buttons to enter your 4-digit PIN, then press **ENTER**.
- Highlight **On**, then press **ENTER**.

Note
 To unlock the buttons on your TV, select **Off**.
 OR
 Press and hold **VOLUME-** on the side of your TV for about 15 seconds until the volume icon appears on the screen.

- Press **EXIT** to close the menu.

- Highlight **Closed Captions**, then press **ENTER**.

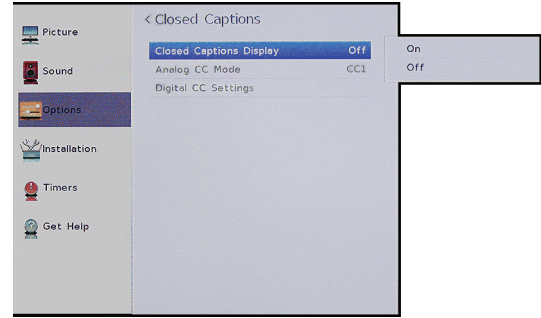

- Highlight **Closed Captions Display**, then press **ENTER**.
- Highlight **On** (turns on closed captioning) or **Off** (turns off closed captioning), then press **ENTER**.
- Press **EXIT** to close the menu.

Note
 You can also press **C.CAPTION** to turn closed captioning on or off.

Using closed captioning

Closed captioning displays a text version of the TV program audio or displays information provided by the broadcaster.

Closed caption controls include:

- Turning closed captioning on or off
- Selecting the analog closed captioning mode
- Selecting the closed captioning mode with the C.CAPTION button
- Customizing digital closed captioning settings

Turning closed captioning on or off

Note
 You may not see closed captioning when:

- A program or video has been dubbed
- Signal reception is weak or non-standard

- Press **MENU**, press **▲** or **▼** to highlight **Options**, then press **ENTER**.

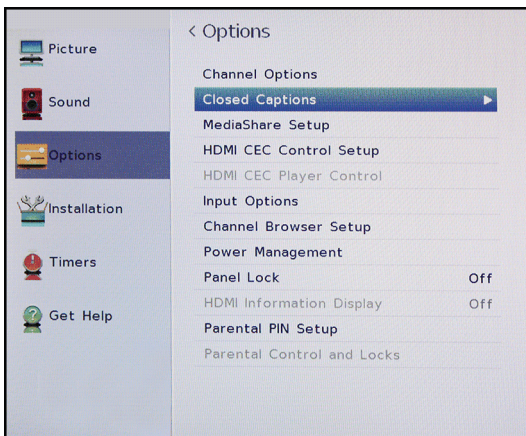

Selecting the analog closed captioning mode

Analog channels usually have one or more closed captioning modes. The CC1 mode usually displays a text version of the TV program audio in a small banner. The other CC modes display information provided by the broadcaster. The Text modes display information in a box that covers half of the screen.

- Press **MENU**, press **▲** or **▼** to highlight **Options**, then press **ENTER**.

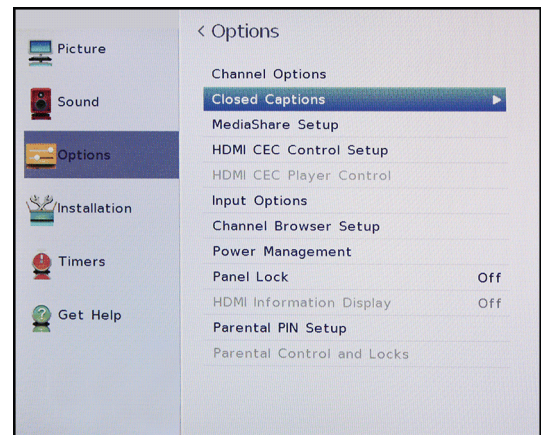

2 Highlight **Closed Captions**, then press **ENTER**.

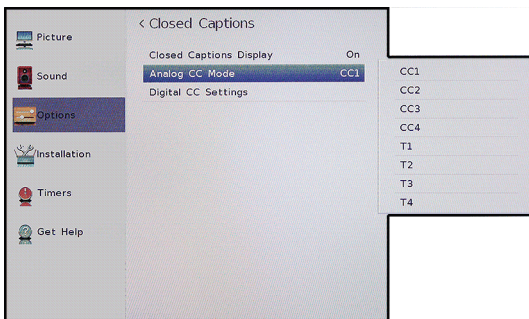

3 Highlight **Analog CC Mode**, then press **ENTER**.

4 Highlight an analog captioning mode, then press **ENTER**. You can select:

- **CC1** through **CC4**—Closed captioning appears in a small banner across the bottom of the screen. **CC1** is usually the “printed” version of the audio. **CC2** through **CC4** display content provided by the broadcaster.
- **T1** through **T4**—Closed captioning covers half or all of the screen. **T1** through **T4** display content provided by the broadcaster.

5 Press **EXIT** to close the menu.

Notes

If the program or video you are watching does not have closed captioning, no captions are displayed.
If **T1** through **T4** is not available in your area, a black rectangle may appear.

Selecting the closed captioning mode with the C.CAPTION button

Press **C.CAPTION**. The CC bar appears:

- If you are tuned to an analog channel (or a video device with a 480i signal), you can select **CC1** through **CC4** or **T1** through **T4**.
- If you are tuned to a digital channel, the available closed captioning modes vary for digital channels.

Customizing digital closed captioning settings

1 Press **MENU**, press **▲** or **▼** to highlight **Options**, then press **ENTER**.

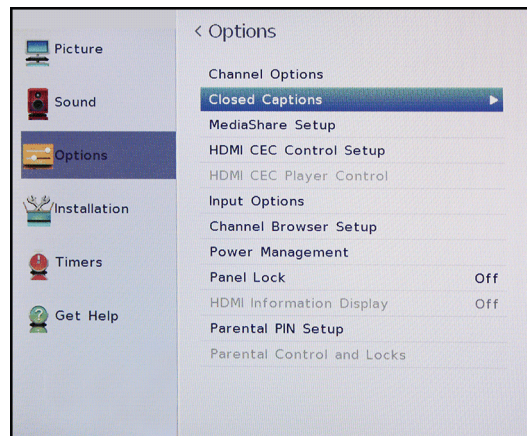

2 Highlight **Closed Captions**, then press **ENTER**.

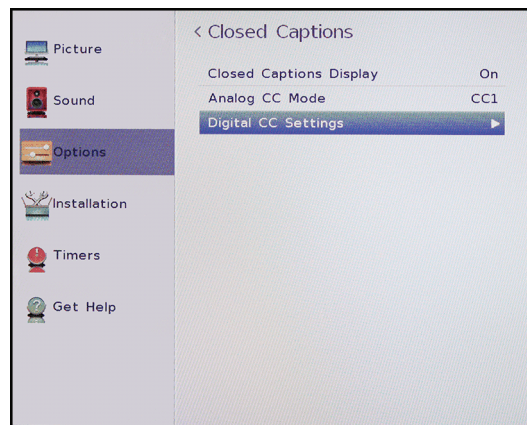

3 Highlight **Digital CC Settings**, then press **ENTER**.

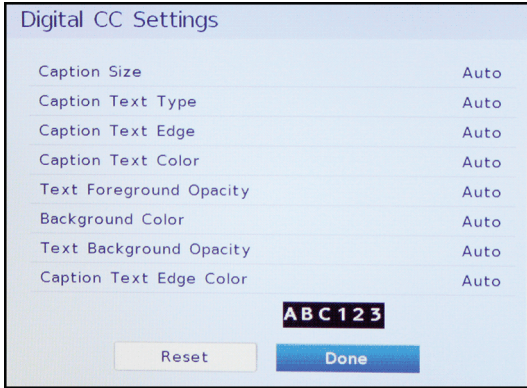

- 4 Highlight an option, then press ◀ or ▶ to adjust the setting. You can select:
- **Caption Size**—Selects the font size.
 - **Caption Text Type**—Selects the font type.
 - **Caption Text Edge**—Selects the style of the letter edge.
 - **Caption Text Color**—Selects the color for the words.
 - **Text Foreground Opacity**—Selects the opacity level for the words.
 - **Background Color**— Selects the color for the background.
 - **Text Background Opacity**—Selects the opacity level of the background.
 - **Caption Text Edge Color**—Selects the color of the letter edge.
- 5 To adjust another option, press ▲ or ▼ to highlight the option, then press ◀ or ▶ to adjust the setting.
- 6 Press **EXIT** to close the menu.

Adjusting time settings

This section includes:

- Setting the time zone and Daylight Saving Time status
- Setting the sleep timer

Setting the time zone and Daylight Saving Time status

Your TV uses the time zone and Daylight Savings Time settings to correctly display program and channel status information.

1 Press **MENU**, press ▲ or ▼ to highlight **Installation**, then press **ENTER**.

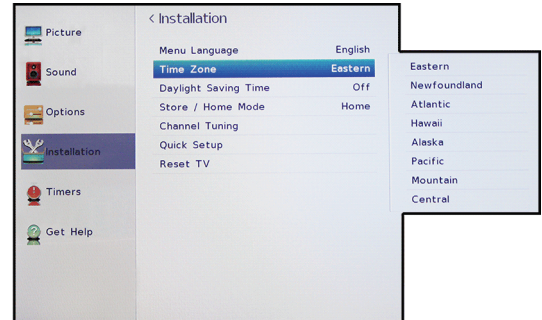

2 Highlight **Time Zone**, then press **ENTER**.

3 Highlight a time zone, then press **ENTER**. The *Installation* menu opens.

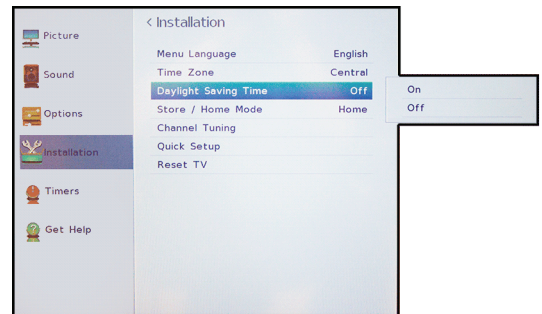

4 Highlight **Daylight Saving Time**, then press **ENTER**.

5 Highlight **On** (if your viewing area observes Daylight Saving Time) or **Off** (if your viewing area does not observe Daylight Saving Time), then press **ENTER**.

6 Press **EXIT** to close the menu.

Setting the sleep timer

You can specify the amount of time before your TV automatically turns off.

- 1 Press **MENU**, press **▲** or **▼** to highlight **Timers**, then press **ENTER**.

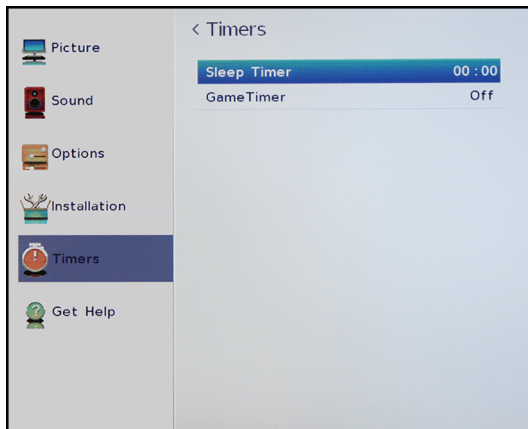

- 2 Highlight **Sleep Timer**, then press **ENTER**.
- 3 Use the number buttons to enter the sleep time.
OR

Press **▲** or **▼** to increase or decrease the sleep time in 10-minute increments.

- 4 Press **EXIT** to close the menu.

Notes

- You can also press **SLEEP** to set the sleep timer.
- To display the time remaining until the TV turns off, press **SLEEP**.
- To cancel the sleep timer, press **SLEEP**, then press **▼** to select **0** minutes.
- If a power failure occurs, the sleep timer setting may be cleared.

Adjusting menu settings

You can adjust how the TV menus look by:

- Selecting the menu language
- Labeling a video input source

Selecting the menu language

You can choose from three different menu language settings (English, Français, and Español) for the on-screen display of menus and messages.

- 1 Press **MENU**, press **▲** or **▼** to highlight **Installation**, then press **ENTER**.

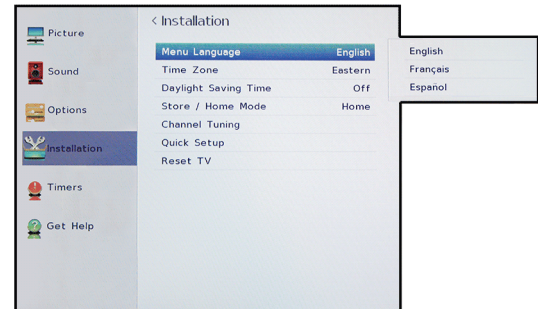

- 2 Highlight **Menu Language**, then press **ENTER**.
- 3 Press **▲** or **▼** to select a language, then press **ENTER**.
- 4 Press **EXIT** to close the menu.

Labeling a video input source

You can add a label to a video input source to make it easier to identify.

You can also hide a video input source so that it is grayed out on the *Input Selection* list and your TV skips the video input source when you press **INPUT**.

- 1 Press **MENU**, press **▲** or **▼** to highlight **Options**, then press **ENTER**.

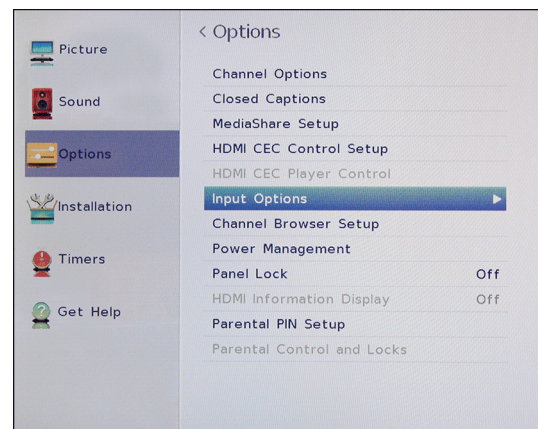

2 Highlight **Input Options**, then press **ENTER**.

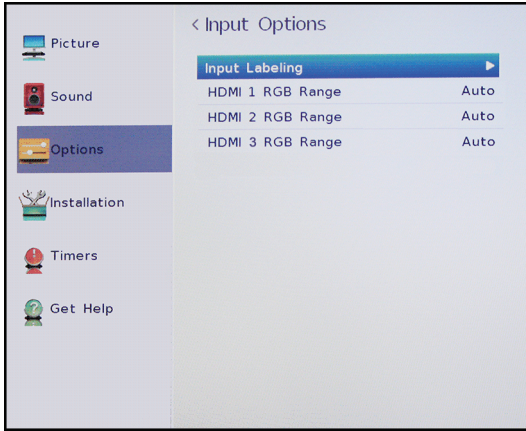

3 Highlight **Input Labeling**, then press **ENTER**.

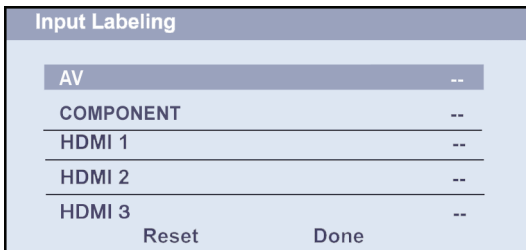

4 Highlight the video input source you want to label, then press ◀ or ▶ to select a label from the list.

Note
If you are not using an input, you can select **Hide** for the label. **Hide** grays the input in the *Input Selection* list and skips the input when you press **INPUT** on the remote control.

5 Repeat steps 3 and 4 to label another input.
6 Press ▲ or ▼ to highlight **Done**, then press **ENTER** to save the label.

OR

Highlight **Reset**, then press **ENTER** to reset the label to the factory default.

7 Press **EXIT** to close the menu.

Notes
To reset the input labels to the default labels, highlight **Reset**, then press **ENTER**.

Maintaining

- Do not use your TV in areas that are too hot or too cold, because the cabinet may warp or the screen may malfunction. Your TV works best in temperatures that are comfortable to you.
- Storage temperatures are 32° to 122°F (0° to 50°C).
- Working temperatures are 41° to 104°F (5° to 40°C).
- Do not place your TV in direct sunlight or near a heat source.

This sections includes topics about:

- [Cleaning the TV cabinet](#)
- [Cleaning the TV screen](#)

Cleaning the TV cabinet

Clean the cabinet with a soft, lint-free cloth. If the cabinet is especially dirty, moisten a soft, lint-free cloth in a weak detergent solution, squeeze the excess moisture from the cloth, then wipe the cabinet with the cloth. Use a clean cloth to dry the cabinet.

Cleaning the TV screen

Clean the screen with a soft, lint-free cloth.

Troubleshooting

Use the following troubleshooting information to solve common problems.

Warning
Do not try to repair your TV yourself. Contact authorized service personnel.

Troubleshooting topics include:

- [Viewing system information](#)
- [Restoring settings to the defaults](#)
- [Turning off the automatic power-off feature](#)
- [Video and audio problems](#)
- [Remote control problems](#)
- [General problems](#)
- [CEC-compatible devices problems](#)

Viewing system information

You may need to view system information during troubleshooting.

- 1 Press **MENU**, press **▲** or **▼** to highlight **Get Help**, then press **ENTER**.

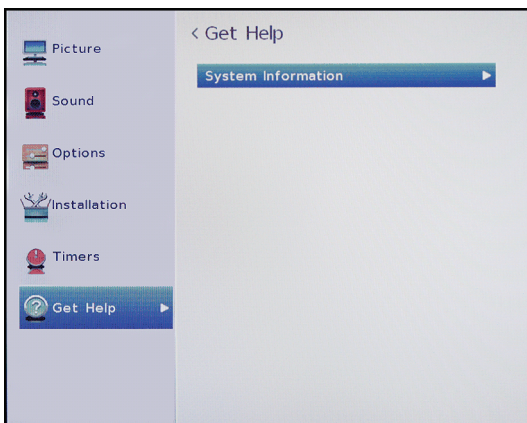

- 2 Highlight **System Information**, then press **ENTER**. Your TV displays information about your system.
- 3 To close the screen and return to the *Get Help* menu, press **ENTER**.

OR

To close the menu, press **EXIT**.

Restoring settings to the defaults

When you restore default settings, all the settings you have customized (except parental controls) are reset.

- 1 Press **MENU**, press **▲** or **▼** to highlight **Installation**, then press **ENTER**.



Note

If you have created a PIN, use the number buttons to enter it, then press **ENTER**.

- 2 Press **▲** or **▼** to highlight **Reset TV**, then press **ENTER**.

A confirmation screen opens.

- 3 Highlight **Yes**, (to reset) or **No** (to not reset), then press **ENTER**.

If you select **Yes**, your TV turns off, then turns on again. Complete the *Initial Setup* wizard and set up the video input jacks. For more information, see [Turning on your TV for the first time](#) on page 39 and [Setting up the video input jacks](#) on page 40.

OR

If you do not want to reset your TV to the factory defaults, highlight **No**, then press **ENTER**.

Turning off the automatic power-off feature

Your TV automatically turns off after 15 minutes when no video signal is detected.

You might want to change this setting to **Off** if:

- The incoming signal for an analog channel is too weak for your TV to detect.
- You connected an audio-only device (such as a CD player) to the **AUDIO L** and **R** jacks to listen to music through the TV speakers.

1 Press **MENU**, press **▲** or **▼** to highlight **Options**, then press **ENTER**.

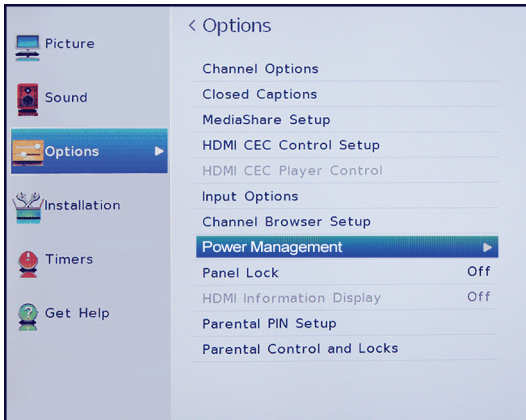

2 Highlight **Power Management**, then press **ENTER**.

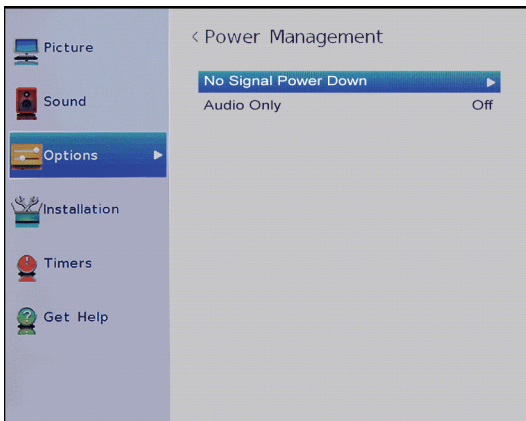

3 Highlight **No Signal Power Down**, then press **ENTER**.

4 Highlight an input source, press **◀** or **▶** to select **Off** or **On**, then press **ENTER**.

5 Press **EXIT** to close the menu.

Video and audio

Problem	Solution
Picture does not fill the screen. There are black bars around the picture.	<ul style="list-style-type: none"> • Press PIC SIZE to change the aspect ratio. See Adjusting the picture size on page 53.
No picture (screen is not lit) and no sound.	<ul style="list-style-type: none"> • Press I/⏻ on the TV or the remote control. • Make sure that the Audio Only option is set to Off. See Playing TV audio only on page 56. • Make sure that the video cables are connected correctly and securely to your TV. • Adjust the contrast and brightness. See Adjusting the TV picture on page 51. • Make sure that the power cord is plugged into a working outlet. • Press INPUT and make sure that the correct video input source is selected. See Selecting the video input source on page 41. • Try another channel. The station may be experiencing problems. • Make sure that the incoming signal is compatible. • Make sure that the antenna or cable TV is connected correctly and securely. See Connecting a cable or satellite box on page 18 or Connecting an antenna or cable TV (no box) on page 23. • Check the closed caption settings. Some TEXT modes can block the screen. See Using closed captioning on page 68.

Problem	Solution
Dark, poor, or no picture (screen is lit), but sound is good.	<ul style="list-style-type: none"> • Try another channel. The station may be experiencing problems. • Make sure that the antenna or cable TV is connected correctly and securely. See Connecting a cable or satellite box on page 18 or Connecting an antenna or cable TV (no box) on page 23. • Adjust the brightness. See Adjusting the TV picture on page 51. • Press PIC SIZE to change the aspect ratio. See Adjusting the picture size on page 53. • If you are using an antenna and the signal strength is low, adjust the antenna or use a highly directional outdoor antenna or set-top antenna with a built-in amplifier. • Make sure that the video cables are connected correctly and securely to your TV. • The video cable(s) you are using may be bad. Try a new set. • Try another channel. The station may be experiencing problems.
No color, dark picture, or color is not correct.	<ul style="list-style-type: none"> • Try another channel. The station may be experiencing problems. • Adjust the color settings. See Adjusting the TV picture on page 51. • Make sure that the video cables are connected correctly and securely to your TV. • Make sure that the antenna or cable TV is connected correctly and securely. See Connecting a cable or satellite box on page 18 or Connecting an antenna or cable TV (no box) on page 23. • If you are using an antenna and the signal strength is low, adjust the antenna or use a highly directional outdoor antenna or set-top antenna with a built-in amplifier.

Problem	Solution
Only snow (noise) appears on the screen.	<ul style="list-style-type: none"> • Try another channel. The station may be experiencing problems. • Make sure that the antenna or cable TV is connected correctly and securely. See Connecting a cable or satellite box on page 18 or Connecting an antenna or cable TV (no box) on page 23. • If you are using an antenna and the signal strength is low, adjust the antenna or use a highly directional outdoor antenna or set-top antenna with a built-in amplifier.
Picture quality is good on some channels and poor on others. Sound is good.	<ul style="list-style-type: none"> • The problem may be caused by a poor or weak signal from the broadcaster or cable TV provider. • If you connect to cable without a set-top box and experience poor picture quality, you may need to install a set-top box to improve signal reception and picture quality. Contact your cable TV provider about upgrading to a set-top box.
Dotted lines or stripes appear on the screen.	<ul style="list-style-type: none"> • Make sure that the antenna or cable TV is connected correctly and securely. See Connecting a cable or satellite box on page 18 or Connecting an antenna or cable TV (no box) on page 23. • If you are using an antenna and the signal strength is low, adjust the antenna or use a highly directional outdoor antenna or set-top antenna with a built-in amplifier. • Make sure that the video cables are connected correctly and securely to your TV. • The video cable(s) you are using may be bad. Try a new set. • Other devices (for example, a surround sound receiver, external speakers, fans, or hair dryers) may be interfering with your TV. Try turning off one device at a time, then back on to determine which device is causing interference. After you have determined which device is causing interference, move it further from the TV to eliminate the interference.
Double images.	<ul style="list-style-type: none"> • Use a highly directional outdoor antenna, cable TV, or satellite TV.

Problem	Solution
The picture has a few bright or dark spots.	<ul style="list-style-type: none"> A few bright or dark spots on an LCD screen is normal. It does not affect the operation of your TV.
Good picture, but no sound.	<ul style="list-style-type: none"> Increase the volume. Make sure that the sound is not muted. Make sure that you do not have headphones connected. When headphones are connected, the TV speakers are muted. Make sure that the TV Speakers option on the <i>Sound</i> menu is not set to Off. If you are using a home theater system, sound bar, or external speaker system, make sure it is turned on and is not muted. If you are using a home theater system, sound bar, or external speaker system, make sure that you have selected the correct output mode. If you are using a home theater system, sound bar, or external speaker system and have connected it with a digital optical cable, go to the <i>Sound</i> menu, highlight Digital Audio Format, then press ENTER. Highlight Audio Format, then press ENTER. Press ▲ or ▼ to select PCM, then press ENTER. See the Digital Audio Format option in Adjusting sound settings on page 55. Make sure that the audio cables are connected correctly and securely to your TV. Make sure that the antenna or cable TV is connected correctly and securely. See Connecting a cable or satellite box on page 18 or Connecting an antenna or cable TV (no box) on page 23. The audio cables you are using may be bad. Try a new set.
Poor picture.	<ul style="list-style-type: none"> Make sure that the room is not too bright. Light reflecting off the screen can make the picture difficult to see. If an S-VHS camera or a camcorder is connected while another connected device is turned on, the picture may be poor. Turn off one or more devices.

Problem	Solution
Good sound, but poor color.	<ul style="list-style-type: none"> Adjust the contrast, color, and brightness settings. See Adjusting the TV picture on page 51.
Audio noise.	<ul style="list-style-type: none"> Other devices (for example, a surround sound receiver, external speakers, fans, or hair dryers) may be interfering with your TV. Try turning off one device at a time to determine which device is causing interference. After you have determined which device is causing interference, move it further from the TV to eliminate the interference.
No output from one of the speakers.	<ul style="list-style-type: none"> Adjust the audio balance. See Adjusting sound settings on page 55. Make sure that the audio cables are connected correctly and securely to your TV.
After images appear.	<ul style="list-style-type: none"> Do not display a still image, such as a logo, game, or computer image, for an extended period of time. This can cause a permanent after-image to be burned into the screen. This type of damage is not covered by your warranty.

Remote control

Problem	Solution
Remote control does not work.	<ul style="list-style-type: none"> Make sure that the power cord is plugged into a working outlet. Make sure that there are no obstructions between the remote control and the remote control sensor on the front of the TV. Point the remote control directly at the remote control sensor on your TV. For the location of the remote control sensor, see Aiming the remote control on page 38. The supplied batteries are wrapped tightly in clear plastic. Make sure that you have removed this plastic from the batteries. Make sure that the batteries are installed correctly. See Installing remote control batteries on page 38. Replace dead batteries with new batteries. See Installing remote control batteries on page 38.

General

Problem	Solution
No power.	<ul style="list-style-type: none"> • Make sure that the power cord is plugged into a working outlet. • Unplug the power cord, wait 60 seconds, then plug the cord back in and turn on your TV. • Other devices (for example, a surround sound receiver, external speakers, fans, or hair dryers) may be interfering with your TV. Try turning off one device, at a time, then turning on your TV to determine which device is causing interference. After you have determined which device is causing interference, move it further from the TV to eliminate the interference.
"No video" error message is displayed.	<ul style="list-style-type: none"> • Press INPUT and make sure that you have selected the correct input for the device or service you are trying to use. • If you are using a cable or satellite box, use the remote that came with that box to change channels.
After Auto Channel Search, there are no channels.	<ul style="list-style-type: none"> • Reception can vary by channel depending on the broadcast power level of a given station. Contact your cable or satellite TV provider. • Make sure that the antenna or cable/satellite TV is connected securely to your TV. • Try replacing the cable between the antenna/cable or cable/satellite box and your TV.
When I press INPUT , I cannot select my device (it is grayed out).	<ul style="list-style-type: none"> • Make sure that the video input source for the device is not hidden. See Labeling a video input source on page 71. • Make sure that the video input sources are not locked. See Locking video inputs on page 65.

Problem	Solution
One or more channels do not display.	<ul style="list-style-type: none"> • Make sure that the channels are not blocked. See Locking channels on page 66. • Make sure that the channels are not hidden. The channel may have been deleted from the channel list. You can tune to the channel by pressing the number buttons or you can add the channel back to the channel list. See Hiding channels on page 60. • If you are using a cable or satellite box, use the remote that came with that box to change channels. • Press INPUT and make sure that you have selected the correct input for the device or service you are trying to use.
Password is lost.	<ul style="list-style-type: none"> • If you forget your PIN, open the screen where you enter your PIN, then press INFO four times within five seconds. The PIN is cleared and you can enter a new PIN. See Setting a new PIN on page 62.
Some settings cannot be accessed.	<ul style="list-style-type: none"> • If a setting is grayed, the setting is not available in the current video input mode (for example TV mode). Change to a different video input source. See Selecting the video input source on page 41.
TV cabinet creaks.	<ul style="list-style-type: none"> • When the TV is in use, the temperature rises naturally and may cause the cabinet to expand or contract which can cause a creaking noise. This is not a malfunction.
Control buttons do not work.	<ul style="list-style-type: none"> • Make sure that the Panel Lock option is set to Off. See Locking control buttons on your TV on page 67. • Unplug the power cord, wait a few seconds, then plug the cord back in and turn on your TV.
TV keeps turning off.	<ul style="list-style-type: none"> • Make sure that the sleep timer is not turned on. See Setting the sleep timer on page 71.
A retail banner is displayed.	<ul style="list-style-type: none"> • You selected Store Mode when you ran the <i>Initial Setup</i> wizard. Go to the <i>Installation</i> menu, highlight Store / Home Mode, then press ◀ or ▶ to select Home, then press ENTER.

CEC-compatible devices

Problem	Solution
My TV is not displaying the video from the connected CEC device.	<ul style="list-style-type: none"> • Make sure that the HDMI cable is connected securely to your TV and the device. • Make sure that the device is connected to your TV with an HDMI cable. • Make sure that the device is a CEC device. See the documentation that came with the device for more information. • Press INPUT and make sure that the correct video input source is selected. See Selecting the video input source on page 41. • Make sure that the HDMI-CEC Control feature is turned on. See Turning HDMI-CEC Control on or off on page 45. • Try adjusting the TV picture. See Adjusting the TV picture on page 51.

Problem	Solution
My TV is not playing the audio from the connected CEC device.	<ul style="list-style-type: none"> • Make sure that the HDMI cable is connected securely to your TV and the device. • Make sure that the device is connected to your TV with an HDMI cable. • Make sure that the device is a CEC device. See the documentation that came with the device. • Make sure that the TV volume is turned up and not muted. • Try adjusting the TV sound. See Adjusting sound settings on page 55. • Make sure that the TV speakers are turned on and not muted. See Adjusting sound settings on page 55. • Make sure that the HDMI-CEC Control feature is turned on. See Turning HDMI-CEC Control on or off on page 45. • If you have connected an HDMI CEC audio receiver, adjust the volume on the receiver. When your TV detects an audio receiver, the TV speakers may turn off and sound plays through receiver speakers only. • If you are using a home theater system, sound bar, or external speaker system, make sure that it is turned on and is not muted. • If you are using a home theater system, sound bar, or external speaker system, make sure that you have selected the correct output mode. • If you are using a home theater system, sound bar, or external speaker system and have connected with a digital optical cable, go to the <i>Sound</i> menu, highlight Digital Audio Format, then press ENTER. Highlight Audio Format, then press ENTER. Press ▲ or ▼ to select PCM, then press ENTER. See the Digital Audio Format option in Adjusting sound settings on page 55.

Problem	Solution
My TV's remote control does not control the device.	<ul style="list-style-type: none"> • Make sure that there are no obstructions between the remote control and the remote control sensors on your TV and the device. • Depending on the device, all the buttons may not work. • Make sure that the HDMI-CEC Control feature is turned on. See Turning HDMI-CEC Control on or off on page 45. • If you are trying to control the volume on an HDMI CEC audio receiver using your TV remote control, make sure that the Amplifier Control option is set to On. See Turning Amplifier Control on or off on page 47. • The device may not support this feature. See the documentation that came with the device for more information.
The device does not show up in the list of CEC devices.	<ul style="list-style-type: none"> • Make sure that the device is turned on. • Make sure that the HDMI cable is connected securely to your TV and the device. • Make sure that the device is connected to your TV with an HDMI cable. • Make sure that the HDMI-CEC Control feature is turned on. See Turning HDMI-CEC Control on or off on page 45. • Make sure that the device is a CEC device. See the documentation that came with the device.
My device does not turn off when I turn off my TV.	<ul style="list-style-type: none"> • Make sure that the HDMI-CEC Control feature is turned on. See Turning HDMI-CEC Control on or off on page 45. • Make sure that Auto Standby is set to On. See Turning Auto Standby on or off on page 46. • The device may not support this feature. See the documentation that came with the device for more information.

Problem	Solution
My TV does not turn on when I turn on my device.	<ul style="list-style-type: none"> • Make sure that the HDMI-CEC Control feature is turned on. See Turning HDMI-CEC Control on or off on page 45. • Make sure that TV Auto Power is set to On. See Turning TV Auto Power on or off on page 46. • The device may not support this feature. See the documentation that came with the device for more information.
I cannot select the Root Menu option. OR The device's root menu does not open when I select Root Menu .	<ul style="list-style-type: none"> • The device may not support this feature. See the documentation that came with the device for more information.

Note
If the problem is not solved by using these troubleshooting instructions, turn off your TV, then turn it on again.

Specifications

Specifications are subject to change without notice.

43-inch (43L310U)

Dimensions and weight

Without stand	22.4 × 38.1 × 3 in. (56.8 × 96.8 × 7.7 cm) 17 lbs (7.7 kg)
With stand	23.9 × 38.1 × 9.4 in (60.7 × 96.8 × 23.9 cm) 17.2 lbs. (7.8 kg)

Screen

Screen size measured diagonally	42.5 in.
Display type	LED
Screen refresh rate	60Hz
Display resolution	1080p
Panel resolution	1920 (H) × 1080 (V)
Aspect ratio	16:9
Contrast ratio (typical)–panel	1,200:1
Dynamic contrast ratio–list value	3,000,000:1
TV Brightness (minimum) cd/m ²	240 nits
Comb filter	3d y/c digital
Response time	8 ms
Horizontal viewing angle	178°
Vertical viewing angle	178°

Display resolutions

HDMI suggested resolutions	1080p, 1080i, 720p, 480p, 480i
Component video suggested resolutions	1080i, 720p, 480p, 480i

Tuner

Analog	NTSC
Digital	ATSC, 8-VSB, Clear-QAM

Inputs

HDMI	3 (side) EDID compliant HDCP compliant
Component video	1 (back)
Composite video	1 (back) Shared with component Y
Shared audio (component and composite)	Yes
PC/VGA	No
3.5mm PC audio input	No
DVI (shared with HDMI)	HDMI IN 1 (DVI)
USB	1 (side) Supports JPEG and firmware upgrade
Antenna/Cable	1 (back)

Outputs

Video	No
Analog audio/Headphone	Yes
Digital audio	1 (optical) (back)
WiFi	No
Ethernet	No

Audio

DTS Tuning Package	DTS TruSurround
Speakers	Number: 2 Watts per channel: 7W

Power

Power consumption	On: 58.1W Standby: <0.5W
Power input	AC120V 60Hz, 1.1A

Miscellaneous

OSD languages	English, French, Spanish
HDMI CEC	Yes
Game Mode	Yes
GameTimer™	Yes
ENERGY STAR qualified	No
Internet connectable	No
TV base screws	M5 type (25 mm length) (4 pcs)
V-Chip (version 2.0)	Yes
Sleep timer	Yes
Channel labeling	No
VESA mount (mm) (horizontal × vertical)	200 × 300
VESA mount screws	M6 type

Note

The length of the wall-mount screws vary depending on the wall-mount bracket you purchased. See the instructions that came with the wall-mount bracket for screw lengths.

49-inch (49L310U)**Dimensions and weight**

Without stand	26 × 43.7 × 3.7 in. (66 × 111 × 9.3 cm) 22 lbs. (10 kg)
With stand	27.6 × 43.7 × 10 in. (70.1 × 111 × 25.4 cm) 22.7 lbs. (10.3 kg)

Screen

Screen size measured diagonally	48.5 in.
Display type	LED
Screen refresh rate	60Hz
Display resolution	1080p
Panel resolution	1920 (H) × 1080 (V)
Aspect ratio	16:9
Contrast ratio (typical)–panel	1,200:1
Dynamic contrast ratio–list value	5,000,000:1
TV Brightness (minimum) cd/m²	250 nits
Comb filter	3d y/c digital
Response time	9 ms
Horizontal viewing angle	178°
Vertical viewing angle	178°

Display resolutions

HDMI suggested resolutions	1080p, 1080i, 720p, 480p, 480i
Component video suggested resolutions	1080i, 720p, 480p, 480i

Tuner

Analog	NTSC
Digital	ATSC, 8-VSB, Clear-QAM

Inputs

HDMI	3 (side) EDID compliant HDCP compliant
Component video	1 (back)
Composite video	1 (back) Shared with component Y
Shared audio (component and composite)	Yes
PC/VGA	No
3.5mm PC audio input	No
DVI (shared with HDMI)	HDMI IN 1 (DVI)
USB	1 (side) Supports JPEG and firmware upgrade
Antenna/Cable	1 (back)

Outputs

Video	No
Analog audio/Headphone	Yes
Digital audio	1 (optical) (back)
WiFi	No
Ethernet	No

Audio

DTS Tuning Package	DTS TruSurround
Speakers	Number: 2 Watts per channel: 8W

Power

Power consumption	On: 78.7W Standby: <0.5W
Power input	AC120V 60Hz, 1.5A

Miscellaneous

OSD languages	English, French, Spanish
HDMI CEC	Yes
Game Mode	Yes
GameTimer™	Yes
ENERGY STAR qualified	No
Internet connectable	No
TV base screws	M5 type (10 mm length) (4 pcs)
V-Chip (version 2.0)	Yes
Sleep timer	Yes
Channel labeling	No
VESA mount (mm) (horizontal × vertical)	200 × 300
VESA mount screws	M6 type

Note

The length of the wall-mount screws vary depending on the wall-mount bracket you purchased. See the instructions that came with the wall-mount bracket for screw lengths.

55-inch (55L310U)

Dimensions and weight

Without stand	29.1 × 49.1 × 3.6 in. (73.9 × 124.7 × 9.3 cm) 30.4 lbs (13.8 kg)
With stand	30.9 × 49.1 × 10 in. (78.6 × 124.7 × 25.4 cm) 31.3 lbs (14.2 kg)

Screen

Screen size measured diagonally	54.6 in.
Display type	LED
Screen refresh rate	60Hz
Display resolution	1080p
Panel resolution	1920 (H) × 1080 (V)
Aspect ratio	16:9
Contrast ratio (typical)–panel	4,000:1
Dynamic contrast ratio–list value	16,000,000:1
TV Brightness (minimum) cd/m ²	220 nits
Comb filter	3d y/c digital
Response time	9 ms
Horizontal viewing angle	178°
Vertical viewing angle	178°

Display resolutions

HDMI suggested resolutions	1080p, 1080i, 720p, 480p, 480i
Component video suggested resolutions	1080i, 720p, 480p, 480i

Tuner

Analog	NTSC
Digital	ATSC, 8-VSB, Clear-QAM

Inputs

HDMI	3 (side) EDID compliant HDCP compliant
Component video	1 (back)
Composite video	1 (back) Shared with component Y
Shared audio (component and composite)	Yes
PC/VGA	No
3.5mm PC audio input	No
DVI (shared with HDMI)	HDMI IN 1 (DVI)
USB	1 (side) Supports JPEG and firmware upgrade
Antenna/Cable	1 (back)

Outputs

Video	No
Analog audio/Headphone	Yes
Digital audio	1 (optical) (back)
WiFi	No
Ethernet	No

Audio

DTS Tuning Package	DTS TruSurround
Speakers	Number: 2 Watts per channel: 10W

Power

Power consumption	On: 92.4W Standby: <0.5W
Power input	AC120V 60Hz, 1.0A

Miscellaneous

OSD languages	English, French, Spanish
HDMI CEC	Yes
Game Mode	Yes
GameTimer™	Yes
ENERGY STAR qualified	No
Internet connectable	No
TV base screws	M5 type (10 mm length) (4 pcs)
V-Chip (version 2.0)	Yes
Sleep timer	Yes
Channel labeling	No
VESA mount (mm) (horizontal × vertical)	200 × 300
VESA mount screws	M6 type

Note

The length of the wall-mount screws vary depending on the wall-mount bracket you purchased. See the instructions that came with the wall-mount bracket for screw lengths.

Legal notices

FCC Statement

This device complies with Part 15 of the FCC Rules. Operation is subject to the following two conditions: (1) this device may not cause harmful interference, and (2) this device must accept any interference received, including interference that may cause undesired operation.

This equipment has been tested and found to comply with the limits for a Class B digital device, pursuant to Part 15 of the FCC Rules. These limits are designed to provide reasonable protection against harmful interference in a residential installation. This equipment generates, uses and can radiate radio frequency energy and, if not installed and used in accordance with the instructions, may cause harmful interference to radio communications. However, there is no guarantee that interference will not occur in a particular installation. If this equipment does cause harmful interference to radio or television reception, which can be determined by turning the equipment off and on, the user is encouraged to try to correct the interference by one or more of the following measures:

- Reorient or relocate the receiving antenna.
- Increase the separation between the equipment and receiver.
- Connect the equipment into an outlet on a circuit different from that to which the receiver is connected.
- Consult the dealer or an experienced radio/TV technician for help.

Warning

Changes or modifications not expressly approved by the party responsible for compliance could void the user's authority to operate the equipment.

Cables

Connections to this device must be made with shielded cables with metallic RF/EMI connector hoods to maintain compliance with FCC Rules and Regulations.

Canadian Notice

CAN ICES-3 (B)/NMB-3(B)

Standard Television Receiving Apparatus — Appareil de réception télévision ordinaire, Canada BETS-7 / NTMR-7

IC Statement

This device complies with Industry Canada licence—exempt RSS standard(s).

Operation is subject to the following two conditions: (1) this device may not cause interference, and (2) this device must accept any interference, including interference that may cause undesired operation of the device.

This equipment complies with IC radiation exposure limits set forth for an uncontrolled environment.

Dolby License Notice and Trademark Acknowledgement



Manufactured under license from Dolby Laboratories. Dolby and the double-D symbol are trademarks of Dolby Laboratories.

HDMI®



The terms HDMI and HDMI High-Definition Multimedia Interface, and the HDMI Logo are trademarks or registered trademarks of HDMI Licensing LLC in the United States and other countries.

DTS TruSurround™



For DTS patents, see <http://patents.dts.com>. Manufactured under license from DTS Licensing Limited. DTS, the Symbol, & DTS and the Symbol together are registered trademarks, and DTS TruSurround is a trademark of DTS, Inc. © DTS, Inc. All Rights Reserved.

Open Source

This production contains Bitstream Vera Sans fonts under the following copyright:

Copyright © 2003 by Bitstream, Inc. All Rights Reserved. Bitstream Vera is a trademark of Bitstream, Inc.

One-year limited warranty - Toshiba Televisions

Definitions:

Best Buy ("Warrantor") warrants to you, the original purchaser of this new Toshiba-branded television ("Product"), that the Product shall be free of defects in the original manufacturer of the material or workmanship for a period of one (1) year from the date of your purchase of the Product ("Warranty Period"). For this warranty to apply, your Product must be purchased in the United States or Canada from a Best Buy authorized dealer of Toshiba brand products only that are packaged with this warranty statement.

How long does the coverage last?

The Warranty Period lasts for 1 year (365 days) from the date you purchased the Product. Your purchase date is printed on the receipt you received with the Product.

What does this warranty cover?

During the Warranty Period, if the original manufacture of the material or workmanship of the Product is determined to be defective by an authorized Warrantor repair center or store personnel, Warrantor will (at its sole option): (1) repair the Product with new or rebuilt parts; or (2) replace the Product at no charge with new or rebuilt comparable products or parts. Products and parts replaced under this warranty become the property of Warrantor and are not returned to you. If service of Products or parts are required after the Warranty Period expires, you must pay all labor and parts charges. This warranty lasts as long as you own your Toshiba Product during the Warranty Period. Warranty coverage terminates if you sell or otherwise transfer the Product.

How to obtain warranty service?

If you purchased the Product at a Best Buy retail store location and your television Product has a screen size of less than 42 inches, please take your original receipt and the Product to any Best Buy store. Make sure that you place the Product in its original packaging or packaging that provides the same amount of protection as the original packaging. If you purchased the Product from a Best Buy online web site, mail your original receipt and the Product to the address listed on the web site. Make sure that you put the Product in its original packaging or packaging that provides the same amount of protection as the original packaging.

To obtain in-home warranty service for a television with a screen 42 inches or larger, in the United States call 1-888-BESTBUY, Canada call 1-866-BESTBUY. Call agents will diagnose and correct the issue over the phone or will have a Toshiba-approved repair technician dispatched to your home.

Where is the warranty valid?

This warranty is valid only in the United States and Canada at Best Buy branded retail stores or websites to the original purchaser of the product in the county where the original purchase was made.

What does the warranty not cover?

This warranty does not cover:

- Customer instruction/education.
- Installation.
- Set up adjustments.
- Cosmetic damage.
- Damage due to acts of God, such as power surges.
- Accident(s).
- Misuse, unintentional or intentional.
- Abuse, unintentional or intentional.
- Negligence.
- Commercial purposes/use, including but not limited to use in a place of business or in communal areas of a multiple dwelling condominium or apartment complex, or otherwise used in a place of other than a private home.
- Modification of any part of the Product, including the antenna
- Damage due to incorrect operation or maintenance.
- Connection to an incorrect voltage or power supply.

- Outages, static or other problems with over-the-air reception of the television broadcast signals.
- Attempted repair by any person not authorized by Warrantor to service the Product.
- Products sold "as is" or "with all faults."
- Consumables, including but not limited to batteries (i.e. AA, AAA, C etc.).
- Products where the factory applied serial number has been altered or removed.
- Loss or Theft of this product or any part of the product
- Failures or Damage caused by any contact including but not limited to liquids, gels or pastes.
- Up to three (3) pixel failures (dots that are dark or incorrectly illuminated) grouped in an area smaller than one tenth (1/10) of the display size or up to five (5) pixel failures throughout the display. (Pixel based displays may contain a limited number of pixels that may not function normally.)
- Problems with delay in motion or action of video images while playing first-person style video games.

REPAIR REPLACEMENT AS PROVIDED UNDER THIS WARRANTY IS YOUR EXCLUSIVE REMEDY FOR BREACH OF WARRANTY. WARRANTOR SHALL NOT BE LIABLE FOR ANY INCIDENTAL OR CONSEQUENTIAL DAMAGES FOR THE BREACH OF ANY EXPRESS OR IMPLIED WARRANTY ON THIS PRODUCT, INCLUDING, BUT NOT LIMITED TO, LOST DATA, LOSS OF USE OF YOUR PRODUCT, LOST BUSINESS OR LOST PROFITS. WARRANTOR MAKES NO OTHER EXPRESS WARRANTIES WITH RESPECT TO THE PRODUCT, ALL EXPRESS AND IMPLIED WARRANTIES FOR THE PRODUCT, INCLUDING, BUT NOT LIMITED TO, ANY IMPLIED WARRANTIES OF AND CONDITIONS OF MERCHANTABILITY AND FITNESS FOR A PARTICULAR PURPOSE, ARE LIMITED IN DURATION TO THE WARRANTY PERIOD SET FORTH ABOVE AND NO WARRANTIES, WHETHER EXPRESS OR IMPLIED, WILL APPLY AFTER THE WARRANTY PERIOD. SOME STATES, PROVINCES AND JURISDICTIONS DO NOT ALLOW LIMITATIONS ON HOW LONG AN IMPLIED WARRANTY LASTS, SO THE ABOVE LIMITATION MAY NOT APPLY TO YOU. THIS WARRANTY GIVES YOU SPECIFIC LEGAL RIGHTS, AND YOU MAY ALSO HAVE OTHER RIGHTS, WHICH VARY FROM STATE TO STATE OR PROVINCE TO PROVINCE.

Product information: www.tv.toshiba.com

Product support (855) 527-2411 For US and Canada

This product is distributed and warranted by Best Buy Purchasing, LLC

©2015 Best Buy China LTD. All rights reserved.

Toshiba is a registered trademark of Toshiba Corporation; All other trademarks are property of their respective owners.

ColorMaster, DynaLight, GameTimer, Native Mode, Stable Sound, Surflock and TheaterWide are trademarks or registered trademarks of Toshiba America Information Systems, Inc.



For product information and support, go to: www.tv.toshiba.com
Product support (855) 527-2411
Distributed and warranted by Best Buy Purchasing LLC
©2015 Best Buy China LTD. All rights reserved.